

**E3 specification**

Viewing head	30° inclined monocular head, with locking mechanism for eyepieces
	30° inclined binocular head, with locking mechanism for eyepieces, right diopter adjustment: ± 5; interpupillary distance range: 50–75mm
	30° inclined trinocular head, with locking mechanism for eyepieces, right diopter adjustment: ± 5; interpupillary distance range: 50–75mm, fixed splitting ratio, R:T=5:5
Eyepiece	Wide field plan eyepiece PL10X/18mm, is able to attach pointer or reticle
Objective	Achromatic objectives 4X/10X/40X/100X
	Plan achromatic objectives 4X/10X/20X/40X/100X
Nosepiece	Quadruple nosepiece
Frame	Low-position coarse and fine adjustment with stop and tighten structure, coarse range: 13mm (combine with fixed stage), 7mm (combine with mechanical stage); fine precision 0.002mm; 0.2W LED illumination (color temperature 5700–6500K), intensity adjustable; power output 100V~240V; power input 5V1A;(Rechargeable frame for option)
Stage	Fixed stage with two clips, 110mmX120mm; N.A.0.65 simple condenser with five-hole rotatable diaphragm
	Double-layer mechanical stage, 115mmX125mm; N.A.1.25 Abbe condenser with iris diaphragm and filter holder
Camera accessory	0.35X/0.5X/0.65X/1X C-mount

**E3 dimension: mm**

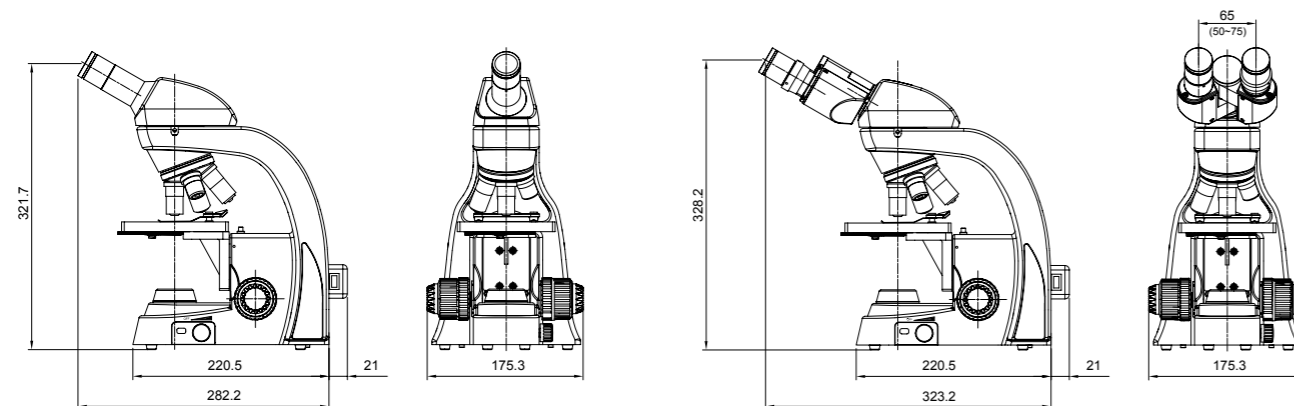

E3 monocular microscope

E3 binocular microscope

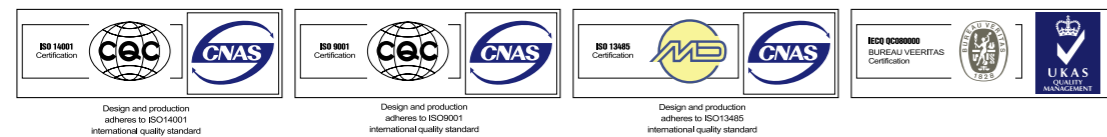

NINGBO SUNNY INSTRUMENTS CO.,LTD.

www.sunnyoptical.com  
E1401B-1902  
No additional notice for changes on the specification or appearance

ADD: No.66-68 Shunyu Road, Yuyao, Zhejiang.  
TEL: 0086-574-62553380  
FAX: 0086-574-62530066  
ZIP: 315400  
E-mail: sales@sunnyoptical.com



# E3 To start a smart life



Curiosity, make it fun, scientifically enlighten children's interests, start a smart life.

E3 series biological microscope with easy operation and clear image, open the door of science world. Its ergonomics design, handy coaxial coarse and fine adjustment, meet the demand of teaching and experiment.

SOPTOP leads every student to recognize the world from micro images.

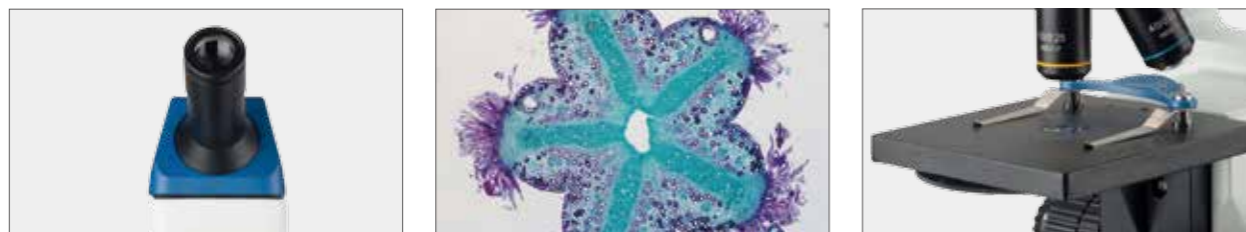

## Micro world, New vision

Outstanding image quality, is helpful for students to understand the main points in teaching, is effective to arouse the initiative and the ability of autonomous learning.

With PL10X/18mm wide field plan eyepiece, E3 creates more comfortable observation experience. Combined with optional plan achromatic objectives, E3 is able to provide a sharp image in natural color, immersive yourself to the micro world and satisfy your desire to explore the unknown.

## Rechargeable LED illumination system

Built-in rechargeable module in the base can be charged when the microscope is working. With long battery life, E3 is able to work when there is no alternate current, is available to make experiment any time and any where.

Charging indicator on the right side of the base, is clear to know the power usage.



Built-in rechargeable module



Charging indicator



## Clear the messy wire harness

Empty space in frame back is designed to store the power line. It is helpful to clean the working environment and effective to avoid the accident when moving the microscope. Adopted USB power line, E3 is able to be powered by computer or portable power source, more convenient and flexible.



## To explore something new

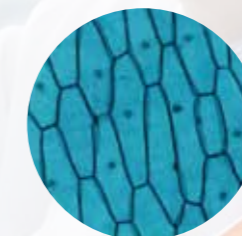

Onion epidermal

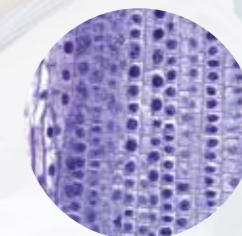

Plant rhizome



Bee hind leg



Mitosis

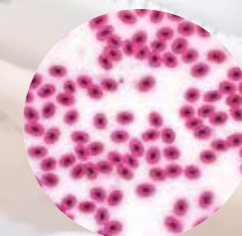

Frog blood

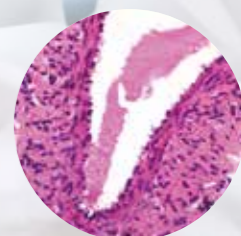

Pathological tissue