

# CX40 LABORATORY BIOLOGICAL MICROSCOPE

## CX40 series system diagram

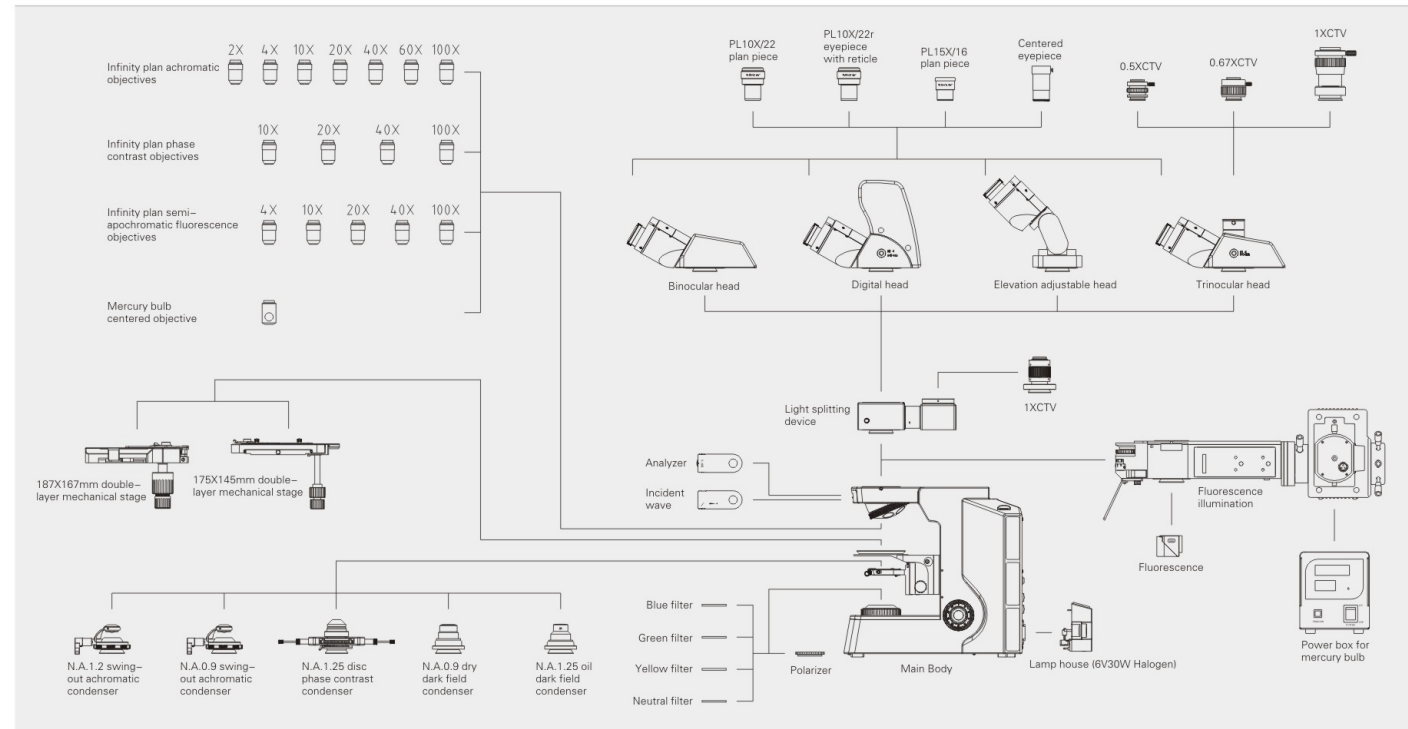

CX40 biological model dimensions: mm

CX40 fluorescence model dimensions: mm

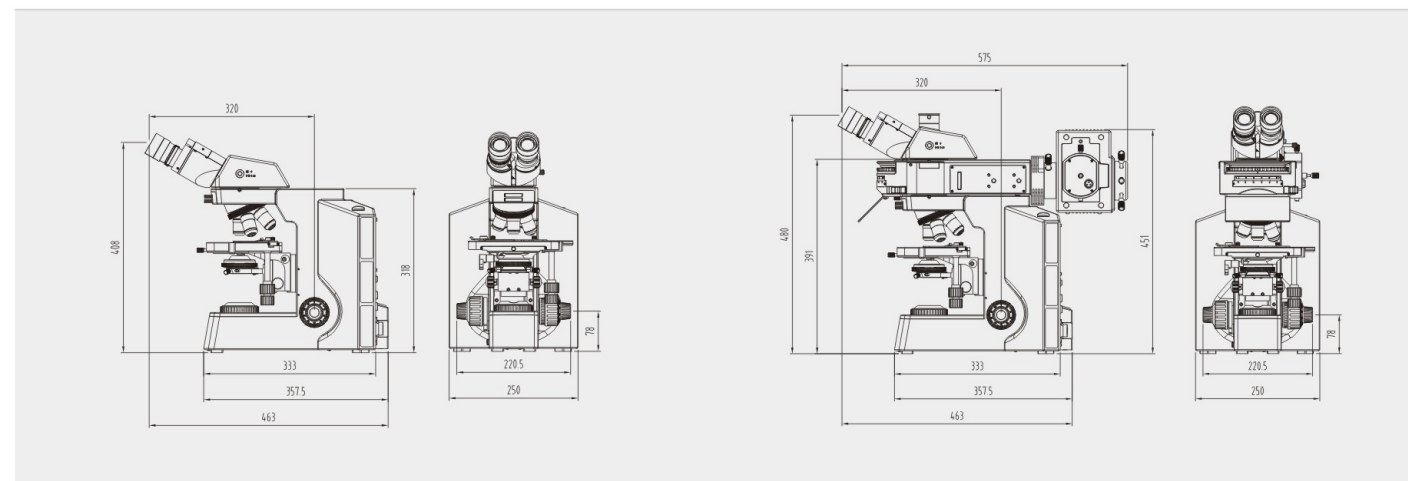

NINGBO SUNNY INSTRUMENTS CO.,LTD.  
[www.sunnyoptical.com](http://www.sunnyoptical.com)  
[www.sunnyoptical-instruments.com](http://www.sunnyoptical-instruments.com)

Add 66-68 Shunyu Rd., Yuyao, Zhejiang, 315400 China  
 Tel 0086-574-62530024  
 Fax 0086-574-62530066  
 E-mail [sales@sunnyoptical.com](mailto:sales@sunnyoptical.com)



As technology improves, manufacturer has the right to make renovation in design without notice.

SUNNY INSTRUMENTS has passed the certificates:  
 ISO 9001  
 ISO 14001  
 ISO 13485



SUNNY INSTRUMENTS  
**CX40 SERIES**

# CX40

## LABORATORY BIOLOGICAL MICROSCOPE

With excellent optical performance and stable system structure, CX40 is professional for biomedicine, pathological diagnosis and other science research.



[www.sunnyoptical.com](http://www.sunnyoptical.com)  
[www.sunnyoptical-instruments.com](http://www.sunnyoptical-instruments.com)



## CX40 Series Characteristics:

- Infinity color corrected optical system, new upgraded Koehler illumination system, presents a clear & bright micro-image under each magnification.
- Fire-new ergonomic design, steady system structure, easy operation, is suitable for various working environments.
- "Building blocks" design for combining multiple functions, fluorescence, phase contrast, polarizing, dark field attachments can be assembled on the basis of bright field observation.
- Widely apply to clinical diagnosis, teaching experiment, pathological test and other micro-fields.



## New structure design, optimized optical system



### High rigidity body structure

Fire-new designed integrative Y-shaped body, all-metal diecasted under high pressure. High stability, no image dithering under high magnification observation, ensures the test precision of multi-channel fluorescence diagnosis.

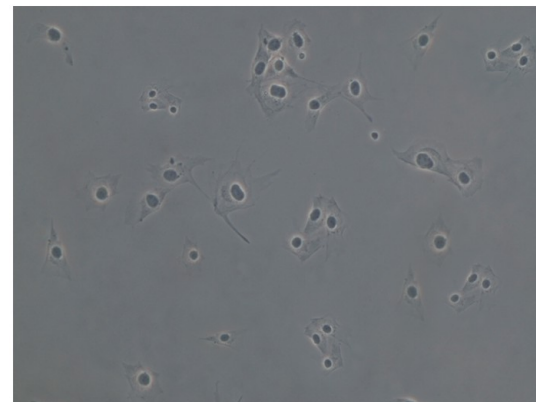
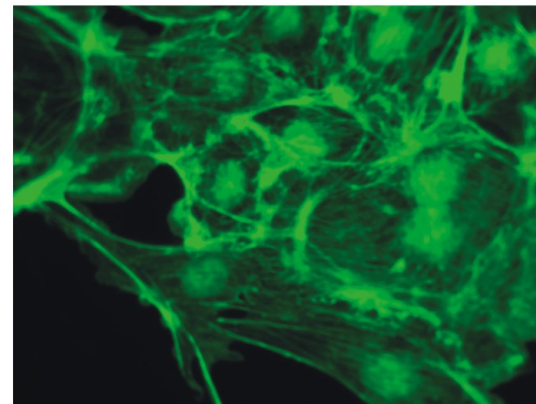
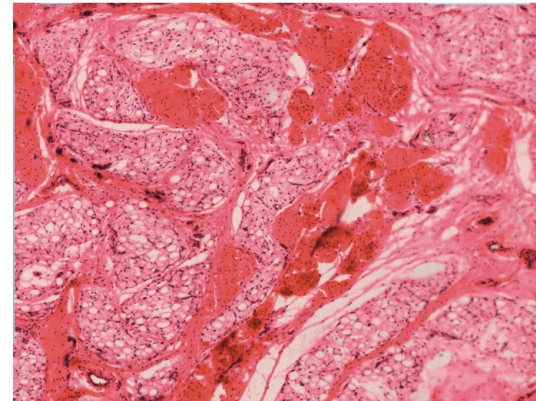

### Focus adjustment

Coaxial coarse and fine adjustment, according with ergonomics design, create the best comfort to operator.

### Screwdriver placement

To make the best of the available space, placing a screwdriver within touch, improves your working efficiency.

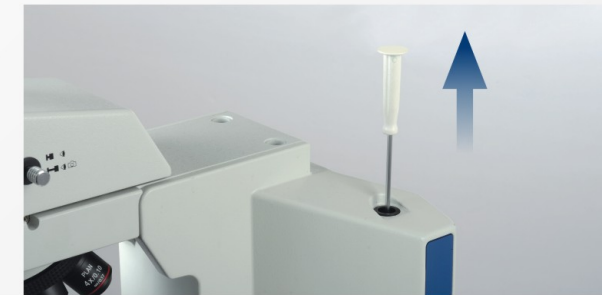

### Koehler illumination system

6V 30W transmitted system, presents a bright and uniform field under every magnification.

Fire-new designed telecentric Koehler illumination system, working with N.A. 1.2/0.22 swing-out achromatic condenser, applies to 2X~100X observation.



### Safe carrying design

The hole on the back of the body make it safe and easy when carry the whole microscope.



### Movable working stage

175x145mm double-layer mechanical stage with operating handle in the right hand.

Damped specimen retainer design, two slices can be put together for testing and analyzing comparatively.

187x167mm large double-layer mechanical stage, is made by oxidized metal. Moving range: 80x55mm, precision: 0.1mm, operating handle in the right hand or left hand, linear driving.



## Leading fluorescence microscopy

### Semi-apochromatic fluorescence objectives

New professional infinity plan semi-apochromatic fluorescence objectives, the best choice for fluorescence observation. Aberration correction and large numerical aperture which is 25% bigger than ordinary objectives, present brighter and clearer image.

Adopting high quality environmental protection optical materials, show an excellent effect in fluorescence observation. With advanced multi-coating wide-band technology, takes the obvious advantages in bandwidth and UV transmittance.

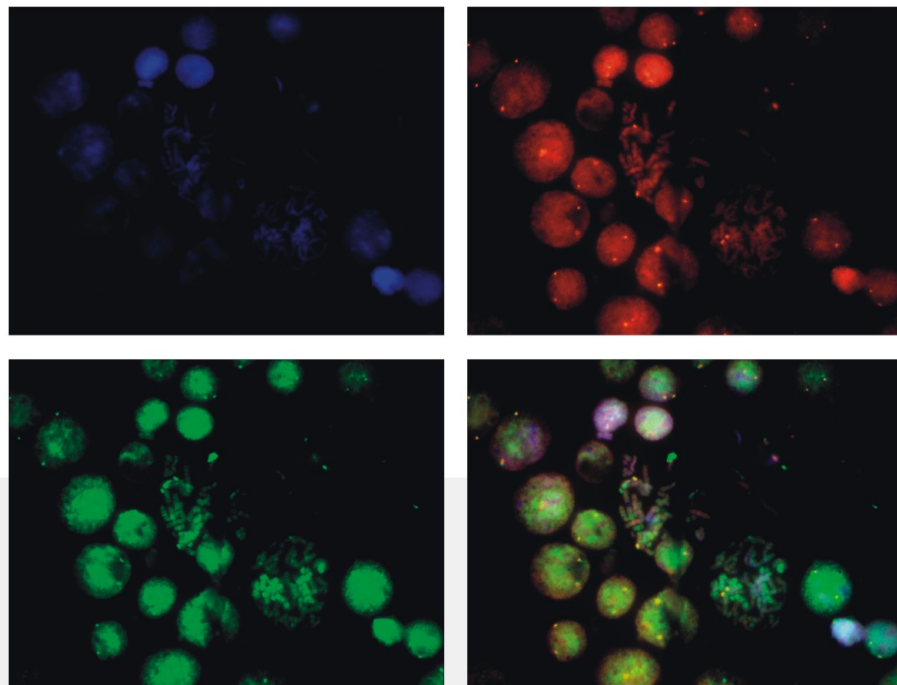

### High-performance fluorescence filters

Imported high performance fluorescence filters, high spectral transmission, good depth and gradient of spectral lines.

No cross color, high S/N ratio, high image contrast. Adopting stray light eliminating technology, high contrast between image and background, creates a perfect observation effect.

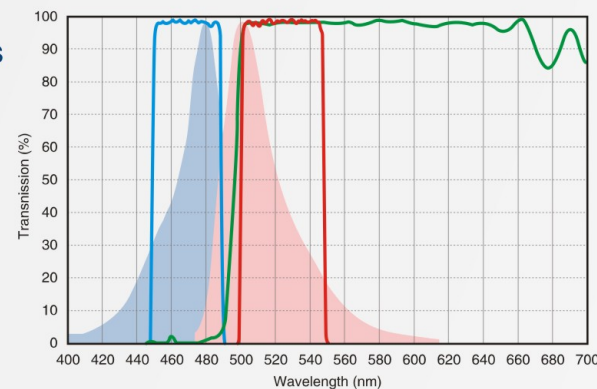

### Disc switching mechanism for filters

Newly designed high-precision disc switching mechanism, is easy to change filters. It guarantees the exact position of the switched filter, can be equipped with six fluorescence filters at most. Selecting driftless high-performance fluorescence filter system, ensures an accurate experiment result of FISH. High transmittance of spectrum without a cross color but a high S/N ratio, promotes dramatically fluorescence imaging contrast.

The filter with stray light elimination technology, presents high contrast between image and its background, achieves the best effect of observation.

### Efficient illumination system

High-graded SiO<sub>2</sub> quartz, with the characteristics of refractory, corrosion-resistant and high UV through rate, makes the illumination more uniform and brighter.

High temperature resistant composite plastic, with heat insulation, effectively prevent the heat of illuminator from transferring to the body.

Alterable field diaphragm with adjustable center, effectively reduce the stray light to obtain the best observation effect.

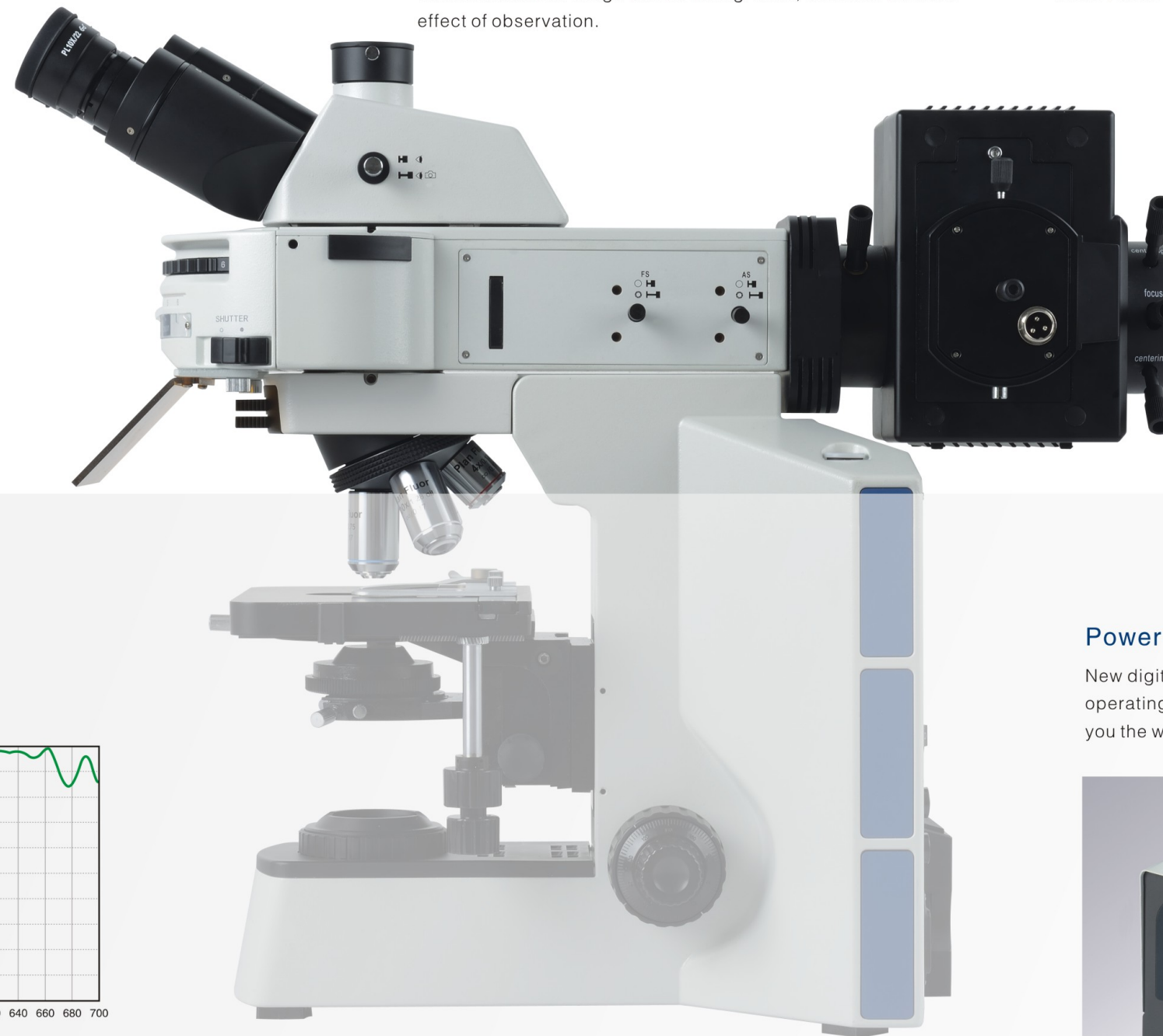

### Power supply for mercury lamp

New digital power control system, displaying operating time and current value, clearly show you the working state of mercury lamp.



## Professional fluorescence image acquisition system



Imported research-grade cold CCD soft, with 1.4 mega pixels, 2/3" sensor size (diagonal), 12V DC high-efficiency semi-conductor-cooling system, perfectly restrain heat signal noise, eliminate dark current effect, greatly increase S/N ratio, and present a professional fluorescence image with high-resolution and high-definition. Adopting USB2.0 high speed transmission interface is convenient to connect with PC.



Smart cool takes full advantages of Windows system and comprehensively supports for WinXP, VISTA, Win7, etc. Chinese interface with the characteristics of simple, intuitive, convenient and fast, offers a variety of powerful tools for area selection which can process and analyze any shaped area. It also can accomplish many professional image processing and analysis, including color adjustment, image warping, mathematical morphology processing, image enhancement, image overlay, texture analysis, feature recognition and so on. It supports for true color image acquisition, and processing and analysis about RGB, CMY, HSV color models. And the function of geometric parameter measurement can make quantitative analysis to slender body, massive body, granular body, threadlike body etc.

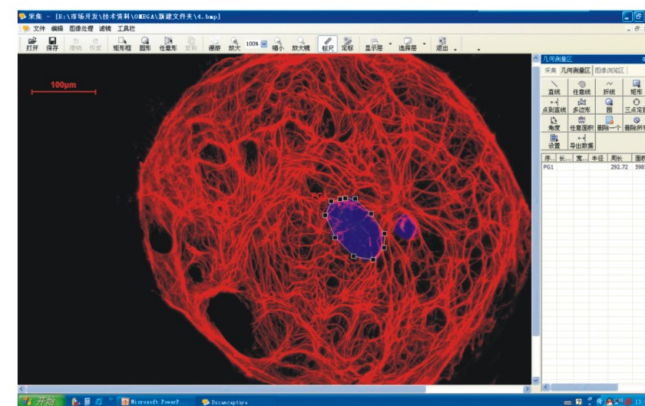

Camera	Model	Single-chip color CCD
	Cooling Mode	Semiconductor Refrigeration
Image Pickup Device	Sensor Size	2/3"
	Effective Pixels	1.4 mega pixels
	Pixel Size	6.45m X6.45m
	Scan Mode	Progressive Scan
Microscope Adapter		Standard C-mount
Image Resolution		1360x1024
Data Transmission	Transmission Interface	USB2.0
	Transmission Speed	480m/s
Picture Format		Bmp/jpg
Preview	Preview Mode	Full Pixel Preview
	Preview Speed	12.5fr/s
Exposure Control		Auto/ Manual
	Exposure Time	0-159.13s, delta0.03s
	Auto Exposure	40-180
White Balance		Auto/ Manual
Operating Temperature		-10°C-60°C
Cooling Temperature		<20°C
Operating Voltage		12V

With digital head and professional image measuring/processing software, DMCX40 is an effective tool for theory teaching, experiment analysis and basic research



## Professional image analysis software MvImage

MvImage software with image process and analysis function, used for automatic analysis and measurement in statistics or morphology. All kinds of detections and analysis related to image morphology can be achieved by MvImage. Such as cell morphology analysis, microstructure analysis, pollutant concentration analysis, seed morphology analysis, chemical industry particle morphology analysis and so on.

- Latest program design, Chinese image-text interface, is the powerful assistant for theory teaching, experiment and basic research.
- Include more than 100 functions, such as chromaticity adjustment, image transforming, texture analysis, feature recognition, etc.
- Support for 24 bit true color image collection, support for processing and analyzing color models like RGB, CMY, HSY, YUV, etc.
- Advanced particle automatic identification, automatic segmentation of blocking particles
- Geometric parameter measurement and auto quantitative analysis, contain common analytic functions

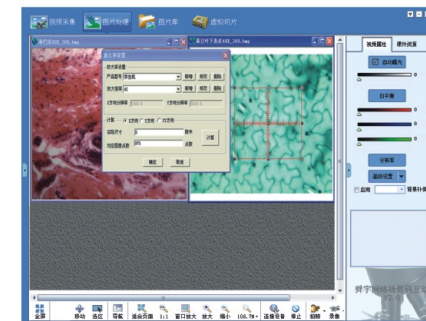

Space-calibration

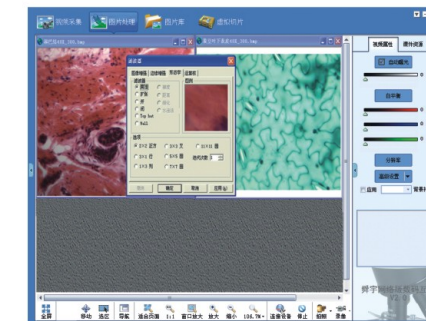

Graphics processing

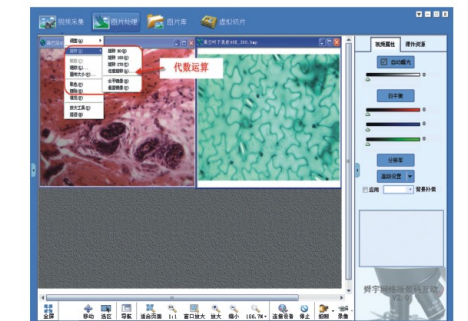

Algebraic operation

# Common fluorescence filter parameter

B1: EGFP/GFP/FITC /Alexa Fluor@488  
Cy2@/DIO/Fluo-4

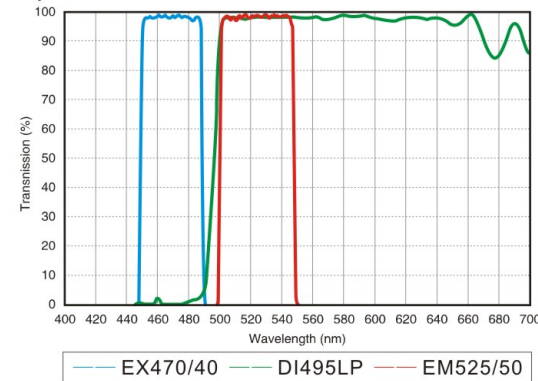

B2: EGFP/GFP/FITC /Alexa Fluor@488  
Cy2@/DIO/Fluo-4

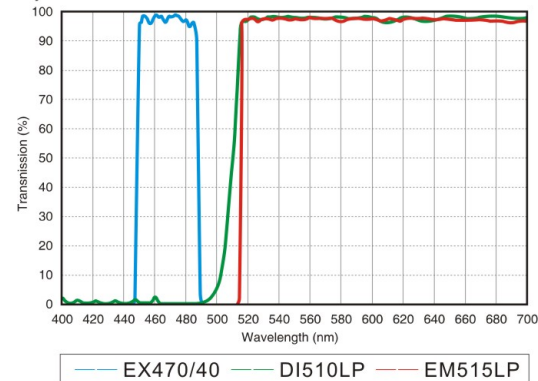

G1: TexasRED@/TexasRed@-X/Cy3.5  
Mito Tracker@Red

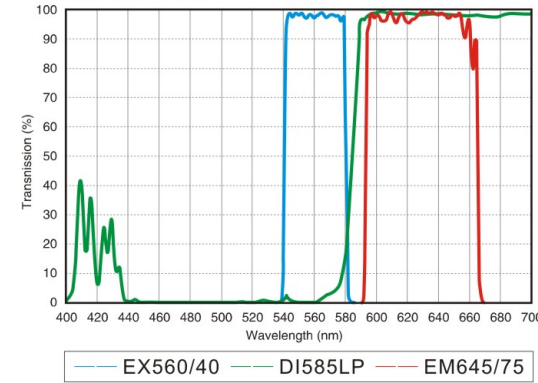

UV1: DAPI/Hoechst 33342/33258 AMCA/  
AMCA-X Blue/ Alexa Fluor@350

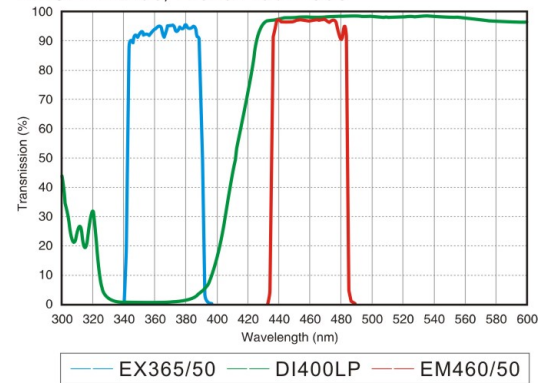

UV2: DAPI/Hoechst 33342/33258 AMCA/  
AMCA-X Blue/ Alexa Fluor@350

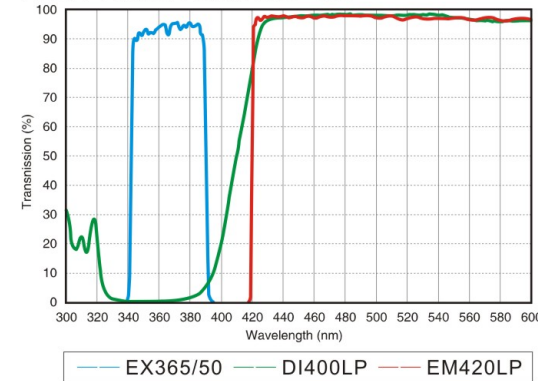

Spectrum Aqua

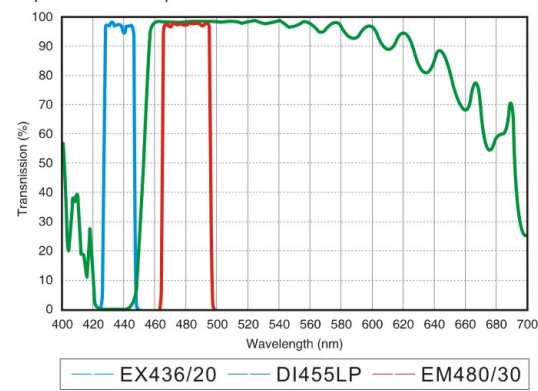

Spectrum Green

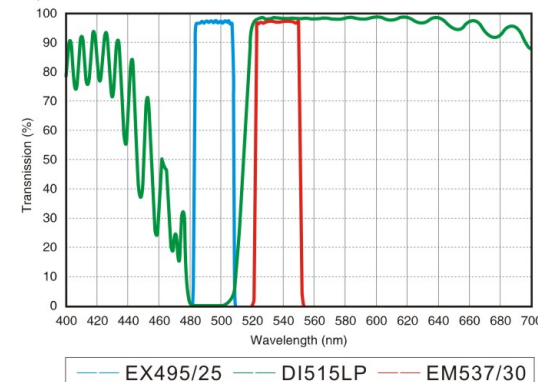

Spectrum orange

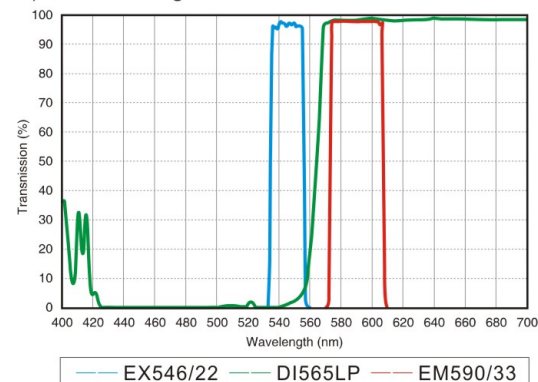

LPLAN series infinity plan achromatic objectives, designed for observing lab pathology and biological cell slices, present sharp and contrast image, work well even in fluorescence observation.



PLAN-PH series infinity phase contrast objectives, improve clarity and contrast, especially suitable to observe colorless or light-colored cells.

PLAN-FLUOR series infinity plan semi-apochromatic objectives, is the best choice for fluorescence observation. Adopting crystal optics materials, perfectly corrects all kinds of chromatic aberrations. Large numerical aperture design presents high resolution, high contrast micro-images. In fluorescence observation, the image is clear and bright while the background is pure black, prominent in ultraviolet fluorescence.

## CX40 objective

Series	Magnification	N.A.	W.D.	F.N.	Cover glass thickness	Immersion	Spring
Plan series	Plan2X	0.06	5.0	22	—	/	/
	Plan4X	0.10	11.9	22	0.17	/	/
	Plan10X	0.25	12.1	22	0.17	/	/
	Plan20X	0.40	1.5	22	0.17	/	/
	Plan40X	0.65	0.36	22	0.17	/	/
	Plan60X	0.85	0.3	22	0.17	/	Yes
Plan PH series	Plan100X	1.25	0.18	22	0.17	Oil	Yes
	Plan PH10X	0.25	12.1	22	0.17	/	/
	Plan PH20X	0.40	1.5	22	0.17	/	/
	Plan PH40X	0.65	0.36	22	0.17	/	Yes
Plan Fluor series	Plan PH100X	1.25	0.18	22	0.17	Oil	Yes
	Plan Fluor4X	0.13	18.5	25	0.17	/	/
	Plan Fluor10X	0.30	10.6	25	0.17	/	/
	Plan Fluor20X	0.50	2.33	25	0.17	/	/
	Plan Fluor40X	0.75	0.6	25	0.17	/	/
	Plan Fluor100X	1.28	0.21	25	0.17	Oil	/



## CX40 series specifications

Optical system	Infinity color corrected optical system
Viewing head	Efficient infinity gemel binocular head, 30° – 60° elevation adjustable; 360° rotatable; interpupillary adjustable distance: 54–75mm; diopter +/-5 adjustable
	30° inclined gemel binocular head; 360° rotatable; interpupillary adjustable distance: 54–75mm; diopter +/-5 adjustable
	30° inclined gemel trinocular head, splitting ratio R:T=50:50 or R:T=0:100; 360° rotatable; interpupillary adjustable distance: 54–75mm; diopter +/-5 adjustable
Eyepiece	30° inclined digital binocular head; 360° rotatable; interpupillary adjustable distance: 54–75mm; diopter +/-5 adjustable
	High eye-point wide field plan eyepiece PL10x22mm, PL15x16mm
	Infinity plan achromatic / phase contrast /semi-apochromatic fluorescence objectives
Objective	Revolving quadruple nosepiece/quintuple nosepiece
Nosepiece	Coaxial focus system with upper limited and tension adjustment; coarse range: 30mm; fine precision: 0.002mm; focus height adjustable
Body	175x145mm double layer mechanical stage, rotatable; with special fabrication processing, anti-corrosive and anti-friction; moving range: 76x50mm, precision : 0.1mm
	187x167mm double layer mechanical stage, moving range: 80x55mm, precision: 0.1mm
Stage	N.A.0.9 swing-out type achromatic condenser; N.A.1.2/0.22 swing-out type achromatic condenser; N.A.1.25 quintuple phase contrast condenser; N.A.0.9 dry dark field condenser; N.A.1.25 oil dark field condenser
Condenser	XYRFLP reflected fluorescence Koehler illumination with alterable field diaphragm and aperture diaphragm (center adjustable)
Reflected fluorescence illumination system	XYLH100HG mercury lamp house with viewfinder; the center and focal length of viewfinder & filament are adjustable
	U2-RFLT100 digital power control box of mercury lamp, wide voltage: 100–240VAC
	Imported OSRAM 100W DC mercury bulb; disc fluorescence filters: UV/VB/G; 30ND25-RFLP / 30ND50-RFLP attenuation plate
Transmitted illumination system	Wide voltage: 100–240V, built-in transmitted Koehler illumination; 6V/30W halogen, pre-centered, intensity adjustable
Polarizing kit	Analyzer 360° rotatable; polarizer and analyzer can be out of light path
Filter	Yellow, green, blue, neutral filter
Light splitting device	R:T=70:30 or 100:0, special 1x CTV
Camera adapter	0.5xCTV, 0.67xCTV, 1xCTV