

Water Purification System

Reliable and Versatile



Always meet your requirements



Introduction

Many laboratories require ultrapure/pure water every day. We understand how important it is for scientists to obtain a choice of water qualities that range from primary grade, for simple routine washing and rinsing, to ultrapure for the most critical science and analytical applications.

Among others, Heal Force applied our expertise gained from years of innovation, to offer water purification systems that prepare water of various specified qualities as reliably, practically and cost-favourably as possible.

This brochure outlines the key features of all the products in our range, which are designed to provide water purification systems covering the three different water types required for research and testing applications.



Water Purification

Systems

Table of Contents

What to look for in an ideal water purification system?



3

Which system is best for you?

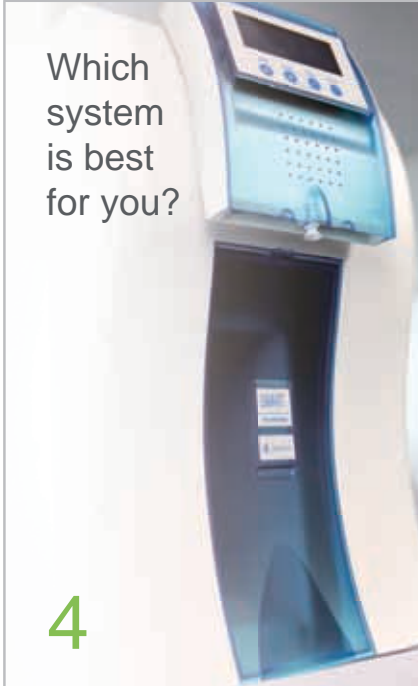

4

Heal Force Features

Technical Processes and Features	5
Additional Designs for Applications	7
How Smart series are differentiated from others?	9
Smart plus- Start Something New!	11

Hea Force Solutions

Smart Plus N/NE	13	Smart RO/RO	24
Smart Plus P	15	Smart ROB/ROB/ROB-R	25
Smart Plus EP	16	ROE 30/70/100	27
Smart N	17	ROE 150/300/500	29
Smart P	19	RO 50/100/150	32
Smart Mini	20	RO 150/300/500	33
EASY	21	ROA 30/50/100/150	36
Smart Plus E	22	ROA 150/300/500	37
Smart ROP/ROP	23		

What to look for in an ideal water purification system?

Heal Force gives you **MORE:**

Multiple technologies into a system

- A comprehensive sequence of water purification process
- A range of cartridges exists to remove specific types of contaminants

Optimal for water quality guarantee

- Resistivity monitoring for high-precision measurement of ionic concentration
- TOC monitoring for prevention of organic breakthrough

Reliability you expect

- Supported by Heal Force worldwide service
- Part of an overall solution that includes design, consumables, instruments and validation

Exceptionally easy to operate

- Easy-to-use graphical interface
- Rapid cartridge replacement
- Convenient pure and ultrapure water delivery

Innovation **TIMELINE**

Water purification systems continue to evolve from basic laboratory equipment to sophisticated and precise one. Heal Force continues to be on the forefront of such advancements with multiple innovations that were first-in-class within this field.

2003

The first generation of water purification system

2006

Super series launched

2007

IP application for some unique designs

2011

Smart series launched with EDI module

2013

Pureforce system with large water production developed

2015

New generation of Smart Plus introduced



Which system is best for you?

Our Solution	Water quality	Typical applications
<ul style="list-style-type: none"> Smart Plus N(T) Smart Plus NE(T) Smart Plus P(T) Smart Plus EP(T) Smart N Smart P Smart Mini Easy 	ASTM Type I ultrapure water	<ul style="list-style-type: none"> BOD tests COD tests DNA microarrays Electrochemistry Electrophoresis Enzyme immunoassays GC(Gas chromatography) GFAAS(Graphite Furnace Atomic Absorption Spectrophotometry) HPLC(High Performance Liquid Chromatography) IC(Ion chromatography) ICPAES(Inductively Coupled Plasma Atomic Emission Spectrometry) ICPMS(Inductively Coupled Plasma Mass Spectrometry)
<ul style="list-style-type: none"> Smart Plus E Smart ROP ROP 	ASTM Type II high pure water	<ul style="list-style-type: none"> AAS(Atomic Absorption Spectrophotometry) Buffer and media preparation Electrophysiology FAAS(Flame Atomic Absorption Spectrophotometry) Feed to ultrapure water systems General chemistry Histology Hydrogen generators Microbiological analysis
<ul style="list-style-type: none"> Smart RO RO 	ASTM Type III pure water	<ul style="list-style-type: none"> Animal watering Aquariums Autoclave feed Feed to ultrapure water system Glassware Washing/rinsing Heat bath Humidifiers
<ul style="list-style-type: none"> Smart ROB Smart ROB-R ROB ROB-R Pureforce ROE 	CAP/CLSI Type I high pure water	<ul style="list-style-type: none"> Automated clinical analysers (Biochemistry, Immunochemistry and immunology)
<ul style="list-style-type: none"> RO Pureforce RO 	<ul style="list-style-type: none"> Healthcare applications EN15883, HTM2030/2031, NHS MESC52, MDA/HIS, ISO 15883 part 4, EN285 	<ul style="list-style-type: none"> Automated endoscope reprocessors Washer disinfectors Autoclaves
<ul style="list-style-type: none"> ROA Pureforce ROA 	<ul style="list-style-type: none"> Low microbiological levels in a high purity water system 	<ul style="list-style-type: none"> Water laboratory animals



Our team of technical and application specialists is always available to answer any questions, as well as providing friendly, expert advice in choosing the most suitable water purification system.

Technical Processes and Features

Water purification is often a complex process that incorporates multiple technologies into a single purification system

Patented Pretreatment Cartridge

- Compression molding process prevents water leakage risk from your safety
- Column is filled with active carbon integrally removing free chlorine in tap water
- PP cotton removes particles, effectively guarding RO membrane from clogging
- Strengthened pretreatment cartridge & water soften column is optional for hard water

01



Reverse Osmosis Module

- Highest quality DOW reverse osmosis systems with state of the art spiral membranes
- Remove inorganic ions, bacteria and particulates with high efficiency
- Automated forward and backward rinse to clean the membrane surface ensures stability and durability
- Flow restriction design keeps reverse osmosis membrane wet to maximize its lifespan

02



High-Strength UV lamp

- Dual wavelength UV lamp ensures organic molecule oxidation and bacteria destruction
- UV lamp is activated only when ultrapure water is produced
- Water inlet at bottom of the cartridge to avoid trapping air bubbles
- Held in a robust and corrosion-resistant stainless steel housing
- High transmittance synthetic quartz sleeve for higher efficiency

03

Purification Cartridge

- Adoption of high quality precision grade resin
- Dual-column design increases the ion exchange capacity of consumables and minimizes running costs

04

Ultra-Purification Cartridge

- Adoption of high quality nuclear grade resin
- Polishing cartridge removes ionic and organic contaminants below trace levels
- Active carbon supplement* restrain organic level inside the cartridge effectively.

05

* Applicable for CR-SP303M

Ultra-Filtration Filter / Micro Filter

06

- Effectively filter out endotoxin, proteins and nucleases, which is critical for tissue culture, cell culture and media preparation*
- The large ultrafiltration area and automatic surface rinse ensure both a high flow rate and a long service life.
- Easily switch to alternative microfilters for different applications

*Ultra-Filtration Filter

Point-Of-Use filter

- 0.22 μm membrane filter farthest eliminates contaminants that might interfere with specific application at dispensing point

07

Delivered water maintain consistent peak quality and unqualified water is automatically recirculated

More Featured Designs for Applications

Microprocessor Control

- Fully automatic and self-diagnostic system monitors and controls working condition.
- PIN-coded access to software set points prevents unauthorized changes to operation or system settings.

Comprehensive Sanitization

Unlike many other systems, Heal Force entire fluid pathway is included in the automated disinfection process ensuring complete sanitization.

Module-designed Cartridges

- High quality and economical due to disposable integrated purification column design.
- Easy replacement and quick connection.

High precision resistivity meter

- Flow-through structure make sure the real-time measurement of the actual ionic concentration in water
- Low cell constant (0.01cm⁻¹) to ensure optimum measurement accuracy of low ionic contamination
- Automatic temperature compensation (0.1 °C resolution) makes the value displayed on the screen meaningful



strengthened pre-treatment module

Easy-to-read LCD display

User-friendly LCD provides optimal convenience, with indication on conductivity, resistivity, reservoirs water level and consumable changing reminder to ensure water quality.

Optional strengthened pre-treatment module

20' size long cartridge contains detergent. Therefore, besides the feature of higher water throughput, feed water with extremely low quality can be properly dealt with

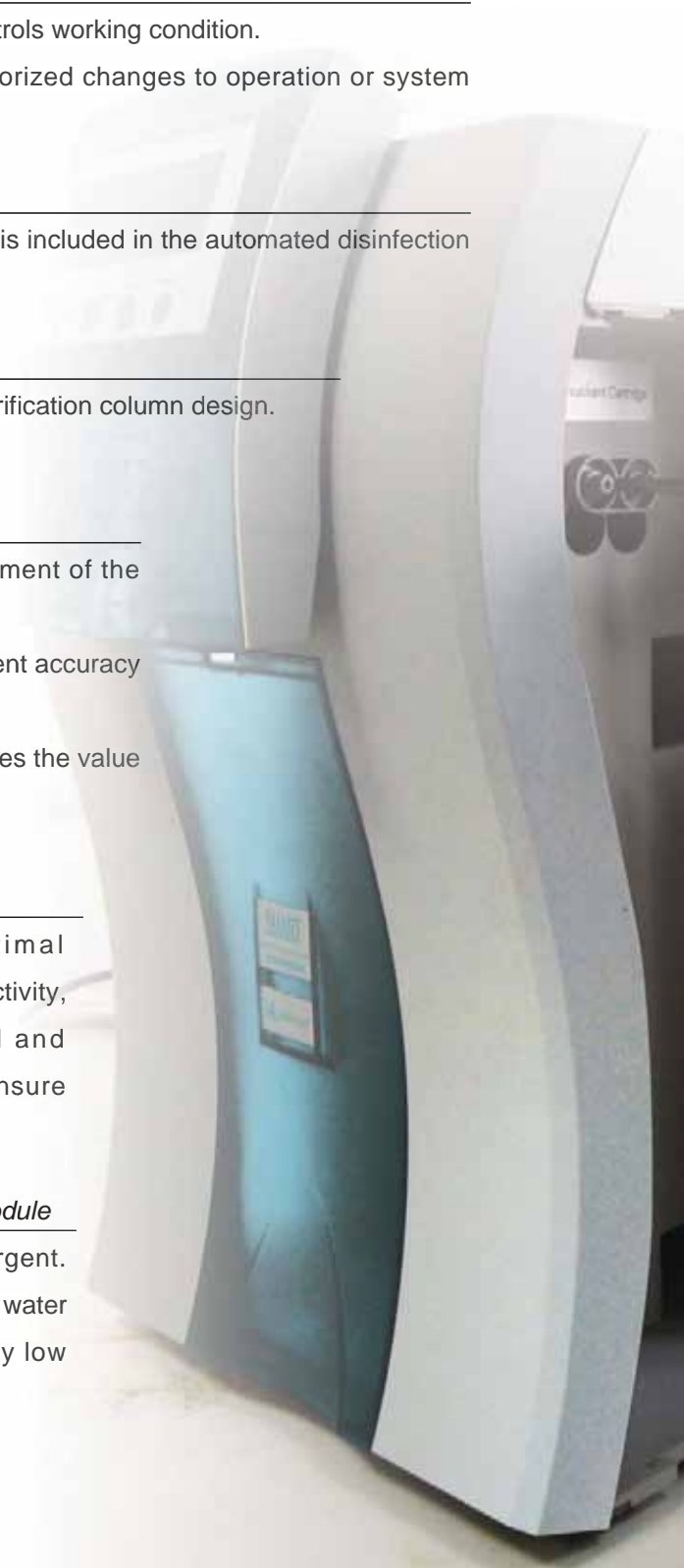

Contamination-Free Water Tank

- Water level sensor combined with bottom pump enables 5-level automatic water production controls
- Capacity of water reservoir includes 30L and 60L. Moreover, ultra big 350L water reservoir is available for special needs
- The water reservoir is made through cylindrical mold and blow molding process to avoid the generation of velum
- PE material ensure low extractives
- Overflow protection tube eliminates the risk of flooding
- Cone shape bottom guarantees no stagnant water and facilitates easy clean
- Optional UV lamp and vented filter maintain consistent purity of stored water and provide effective protection against airborne contaminants.



30L water tank



60L water tank



UV lamp for water tank



Vented filter



Network Compatible

RS232 port allows for data collection and permanent record of water quality and system parameters, with date and time, to a PC or printer - essential for compliance with good laboratory practice guidelines



Smart Series

Inspire the next generation of water purification system

How Smart series differs from other compact class systems ?

Simplest operation!

- Just four control keys allow for rapid operational readiness to improve user experience
- Everything else is automatically managed by the built-in microprocessor control system
- PIN-coded access to software set points prevents unauthorized changes to operation or system settings

Rapid cartridge replacement!

- One, two, three... rapid cartridge change due to quick-connection
- Water purification progresses through separate modules, each with quick connects for simple individual replacement
- Streamlined appearance and intelligent structural design with easy-access door means system can be located under bench
- Quick and easy sanitization and replacement of consumables reduce maintenance time

Reliable work!

- Integrated feedwater check
- Good quality feedwater is a basic requirement for the degree of purity of the water produced, as well as for the long service lives of all purification stages.
- An additional measuring cell permanently monitors the conductivity of the feedwater. Any exceeding of the limiting value is immediately displayed.

Conductivity measurement!

- The high-precision conductivity measuring cells are individually measured out and each value deposited in the system
- The electronics are automatically calibrated and controlled prior to each measurement.

Temperature compensation!

- Platinum chip temperature sensors with an accuracy of +/- 0.1° C are used here
- The temperature compensation can be switched off. USP requirements are fulfilled and optimal measurement reliability ensured.

Flexible dispensing!

- Remote water dispenser with ergonomical design comforts your water delivery experiences.
- The height and direction of dispenser is adjustable for different positions. Action radius is 25cm
- The dispensing pistol can be removed from dispenser arm to expand your working area.
- Full recirculation guarantees water quality at point-of-use
- Auto-volume dispense from 100ml to 60 liters and repeat dispensing
- Foot-pedal activation is available to allow hands-free delivery in a clean room, further reducing the possibility of contamination.



Clear information!

The large easy-to-read LCD display affords the user optimal convenience, with indication on:

- The temperature in °C
- The temperature-compensated conductivity/resistivity of water
- The operating mode status, such as production, stand-by
- Liquid level in water tank
- Consumable changing reminder



Water leakage protection!

Water leakage sensor is linked to the microprocessor system to automatically cut off water input and activate alarm in the situation of leakage

Space saving!

- Each Smart series can be optional installed space-savings under the bench, in a lab table, or mounted directly to the wall (without the need for extra mounting material).
- Remote dispenser can be connected to the main system at a distance of 3 meters. You can get water from height adjustable arm, or hand-held dispensing at each point-of-use



Smart Plus

Start Something new

Not just a bigger display. A better display

It's one thing to make a bigger display. It's something else entirely to make a bigger Touch display with brilliant colors and higher contrast at even wider viewing angles.



Smart plus touch screen

Online TOC for prevention of organic breakthrough

Constant real-time Total Organic Carbon (TOC) monitoring* allows you to verify that the system's organic contaminants removal process is operating within specifications

Several benefits:

- Oxidation and conductivity measurements occur in the same cell. As a result, the monitor checks that all organics have been oxidized in order to deliver an accurate and reproducible TOC value
- An accurate measurement of TOC between 1 and 300 ppb is provided, based on extended calibration
- The design allows performance of the TOC suitability test as required by USP 643 and EP (European Pharmacopoeia)

*For models with TOC capability

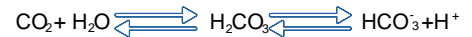
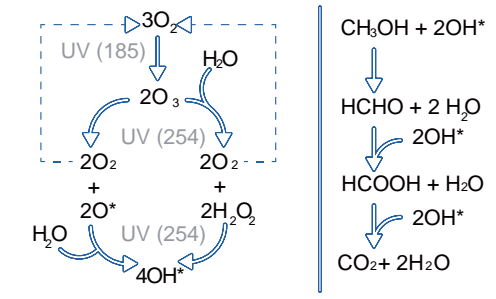

TOC oxidation and conductivity change

Premium water delivery

- Each remote water dispenser has a backlit screen enabling the user to check system operation and water quality at a glance.
- Dispenser units are placed on a recirculation loop, and can be located up to 3 meters from the main unit or from the previous dispenser on the loop.
- Easy operation that allows users to select either manual or automatic delivery to save valuable time.
- Dispensers are designed to accommodate all commonly used glassware.
- For hands-free water delivery, an optional footswitch can be connected to the system. Press once to start and once to stop.



Remote water dispenser with color display

EDI know-how

- Adoption of Electrodeionization (EDI) module brings benefits including lower energy consumption; lower maintenance cost; better ion exchange and no particulates or organic contamination
- The Smart Plus NE/Smart Plus E models incorporates state-of-the-art Electrodeionization (EDI) technology to purify the water instead of only using conventional ion exchange.
- EDI is an electrically-driven water purification process which involves the use of Ion Exchange Resins and Ion Permeable Membranes. Resins are continuously regenerated by the electrical current and are never exhausted.

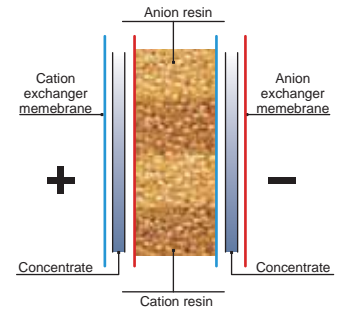

EDI

What benefits you can get

- Constant high efficient removal of ions and small MW charged organic (Resistivity > 10 MΩ- cm)
- No exchange of spent resins
- No regeneration chemicals
- Low energy consumption
- Typical <10 watt light bulb
- Low operating cost and low maintenance

Full Spectrum UV treatment

- Low microbial and organic specification
- High transmittance synthetic quartz sleeve for higher efficiency
- Patented lamp life indicator is designed to predict lifespan according to actual conditions



Smart Plus N/NE

Introduction

The industry's most complete water purification solution for highly regulated applications.

When your application requires the ultimate in water purity, Smart Plus provides the perfect solution. Consistently delivering water purity of 18.2MΩ.cm and underpinned by the advanced technologies, the Smart Plus enables you to focus on attaining accurate results while ensuring an uninterrupted work flow.



Typical Scientific Applications

- ICP-MS(Inductively Coupled Plasma Mass Spectrometry)
- Molecular biology techniques
- Ultra trace analysis
- Electrochemistry
- Electrophoresis
- GFAAS(Graphite Furnace Atomic Absorption Spectrophotometry)
- HPLC
- IC(Ion Chromatography)
- ICP-AES(Inductively Coupled Plasma Atomic Emission Spectrometry)
- Mammalian and bacterial cell culture
- Molecular biology
- Plant tissue culture
- Qualitative analysis

Configuration

SMART PLUS System	SMART PLUS N	SMART PLUS NT	SMART PLUS NE	SMART PLUS NET
Pretreatment module	○	○	○	○
High pressure pump	○	○	○	○
Reverse osmosis	○	○	○	○
Dual wavelength UV-lamp	○	○	○	○
Ultra-purification cartridge	○	○	○	○
Ultrafiltration cartridge	○	○	○	○
EDI Module	\	\	○	○
Point-of-use filter	○	○	○	○
Storage tank 30L	○	○	○	○
Air filter net for tank	○	○	○	○
UV-lamp sterilizer for water tank	○	○	○	○
Remote water dispenser with color display	○	○	○	○
TOC monitoring module	\	○	\	○

Smart Plus - N/NT

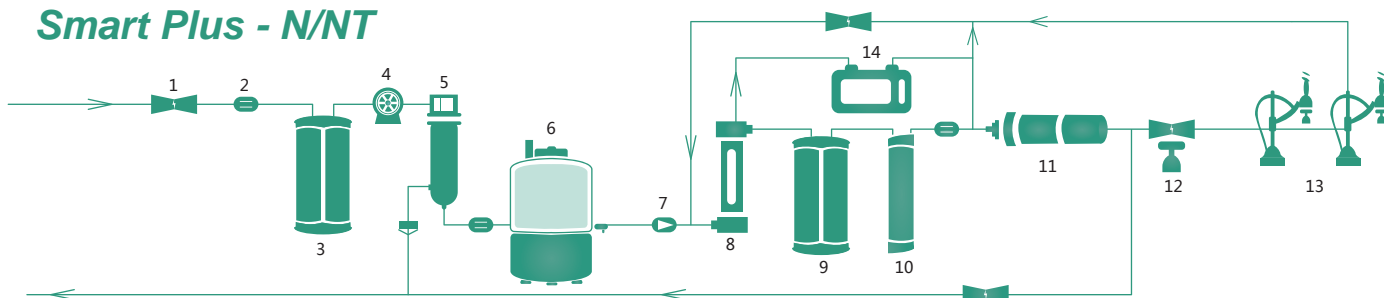

Smart Plus - NE/NET

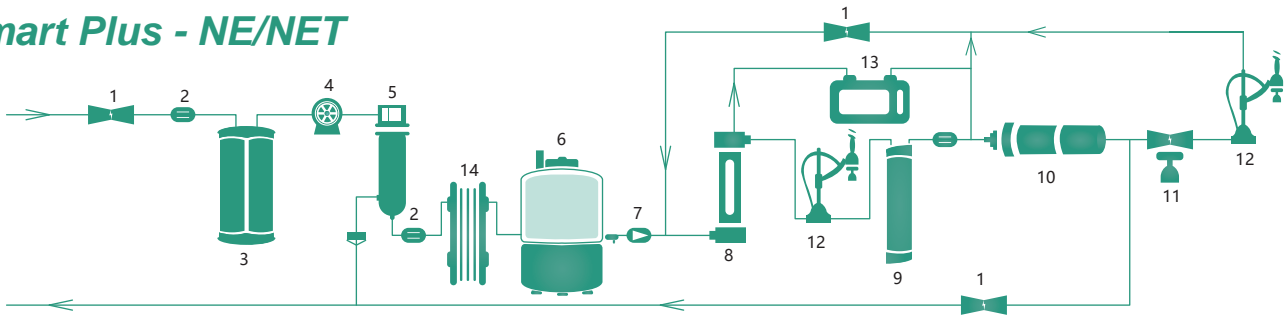

- 1 Solenoid Valve
- 2 Conductivity Sensor
- 3 Pre-treatment Module
- 4 Boost Pump
- 5 RO Module
- 6 Water Tank
- 7 Ball Valve
- 8 Dual Wave UV Cartridge
- 9 Ultra-Purification Module
- 10 Ultra-Filtration Cartridge
- 11 Point-Of-Use Filter
- 12 Remote Water Dispenser
- 13 TOC monitor cell*
- 14 EDI Module

*Applicable for Smart Plus NT/NET

Model	< 0.1 cfu/ml Smart Plus - N	Smart Plus - NT	Smart Plus - NE	Smart Plus - NET
Feed Water Requirement				
Source	Tap water	Tap water	Tap water	Tap water
Conductivity*	<2000us/cm	<2000us/cm	<2000us/cm	<2000us/cm
Hardness**	< 450ppm as CaCO3	< 450ppm as CaCO3	< 450ppm as CaCO3	< 450ppm as CaCO3
Pressure	0.05~0.5MPa(7-72psi)	0.05~0.5MPa(7-72psi)	0.05~0.5MPa(7-72psi)	0.05~0.5MPa(7-72psi)
Temperature	5~40 C	5~40 C	5~40 C	5~40 C
Purification Water(Class III)				
Ionic Rejection	>95%	>95%	>95%	>95%
Bacteria Rejection	>99%	>99%	>99%	>99%
Conductivity	1~20us/cm	1~20us/cm	1~20us/cm	1~20us/cm
Productivity Rate	30L/h	30L/h	30L/h	30L/h
High Quality Purification Water(Class II)				
Resistivity At 25 C	/	/	10MΩ.cm	10MΩ.cm
TOC	/	/	< 30ppb	< 30ppb
Dissolved Organic	/	/	< 0.1ppm	< 0.1ppm
Productivity Rate	/	/	15L/h	15L/h
Ultrapurification Water(Class I)				
Resistivity At 25 C	18.2MΩ.cm	18.2MΩ.cm	18.2MΩ.cm	18.2MΩ.cm
Conductivity At 25 C	0.055us/cm	0.055us/cm	0.055us/cm	0.055us/cm
TOC Level***	1~5ppb	1~5ppb	1~5ppb	1~5ppb
Endotoxin(Pyrogens)****	<0.001EU/ml	<0.001EU/ml	<0.001EU/ml	<0.001EU/ml
Particulate(≥0.02um)	< 1pc/ml	< 1pc/ml	< 1pc/ml	< 1pc/ml
Bacteria***	<0.1 cfu/ml	<0.1 cfu/ml	<0.1 cfu/ml	<0.1 cfu/ml
Rnase / Dnase**	Free	Free	Free	Free
Manual dispense flow rate	1.5~2.0L/min	1.5~2.0L/min	1.5~2.0L/min	1.5~2.0L/min
Automatic dispense volume	100~60000ml	100~60000ml	100~60000ml	100~60000ml
Electrical Requirements				
Electrical Voltage	110V/220V±10%	110V/220V±10%	110V/220V±10%	110V/220V±10%
Electrical Frequency	50HZ/60HZ	50HZ/60HZ	50HZ/60HZ	50HZ/60HZ
Packing Information				
Net Weight				
Main units	34kg	34kg	35kg	35kg
Water tank (30L)	7kg	7kg	7kg	7kg
External Dimensions(W×D×H)				
Main units	315×525×570mm	315×525×570mm	315×525×570mm	315×525×570mm
Water tank (30L)	380×380×595mm	380×380×595mm	380×380×595mm	380×380×595mm
Shipping weight				
Main units	37kg	39kg	37kg	37kg
Water tank (30L)	15kg	15kg	15kg	15kg
Shipping Dimensions(W×D×H)				
Main units	525×610×770mm	525×610×770mm	525×610×770mm	525×610×770mm
Water tank (30L)	520×440×615mm	520×440×615mm	520×440×615mm	520×440×615mm

* If feed water quality is poor(Conductivity> 1000us/cm), strengthened pretreatment module and RO-2 type is highly recommended

** When hardness of feed water is high(>450ppm as CaCO3), 0.5T water softener is recommended

*** Dual wave UV module need to be adopted. Also dependent on feed water, recommended feed TOC< 30ppb

****Ultra-filtration module need to be adopted. Feed water need to be satisfied as above

Smart Plus P

Introduction

The Smart Plus P system has been designed especially for you. Using an existing source of pure water as feed, the Smart Plus P system delivers high-quality ultrapure water (resistivity value: 18.2MΩ.cm @25 °C; ≤5ppb), providing an ultrapure water solution adapted to today's laboratory environments.



Configuration

SMART PLUS P System	Smart Plus P	Smart Plus PT
Storage tank 30L	○	○
Dual wavelength UV-lamp	○	○
Ultra-purification cartridge	○	○
Ultrafiltration cartridge	○	○
Point-of-use filter	○	○
Air filter net for tank	○	○
UV-lamp sterilizer for water tank	○	○
Remote water dispenser with color display	○	○
TOC monitoring module	\	○

Smart Plus P

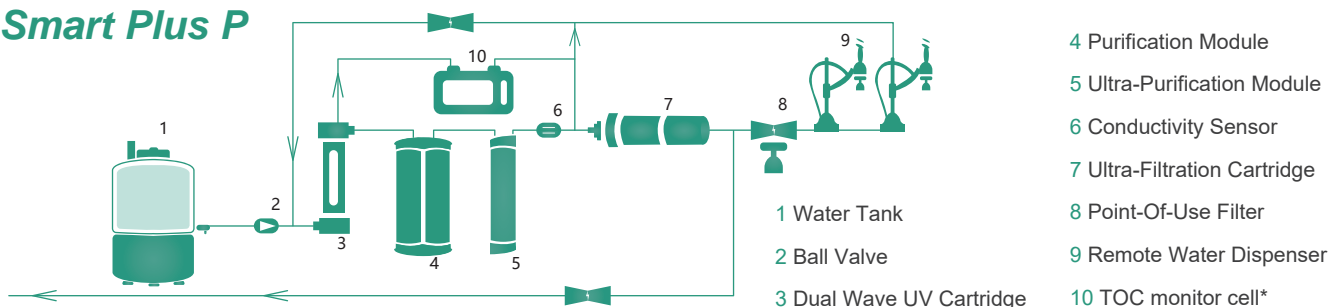

Model	Smart Plus P	Smart Plus PT
Feed Water Requirement		
Source	RO, Distilled, DI water (Conductivity < 20µs/cm)	RO, Distilled, DI water (Conductivity < 20µs/cm)
Temperature	5~40 °C	5~40 °C
Ultrapurification Water(Class I)		
Resistivity At 25 °C	18.2MΩ.cm	18.2MΩ.cm
Conductivity At 25 °C	0.055us/cm	0.055us/cm
Flow Rate	1.5~2.0L/min	1.5~2.0L/min
TOC Level*	1~5ppb	1~5ppb
Endotoxin(Pyrogens)**	< 0.001EU/ml	< 0.001EU/ml
Particulate(≥0.02µm)	< 1pc/ml	< 1pc/ml
Bacteria*	< 0.1cfu/ml	< 0.1cfu/ml
Rnase/Dnase**	Free	Free
Electrical Requirements		
Electrical Voltage	110V/220V±10%	110V/220V±10%
Electrical Frequency	50Hz/60Hz	50Hz/60Hz
Packing Information		
Net Weight		
Main units	32kg	32kg
Water tank (30L)	4.5kg	4.5kg
External Dimensions(W×D×H)		
Main units	315×525×570mm	315×525×570mm
Water tank (30L)	380×380×595mm	380×380×595mm
Shipping weight		
Main units	45kg	45kg
Water tank (30L)	13kg	13kg
Shipping Dimensions(W×D×H)		
Main units	525×610×770mm	525×610×770mm
Water tank (30L)	520×440×615mm	520×440×615mm

* Dual wave UV module need to be adopted. Also dependent on feed water, recommended feed TOC < 30ppb

**Ultra-filtration module need to be adopted. Feed water need to be satisfied as above

Smart Plus EP

Introduction

A comprehensive and optimized sequence of water purification and monitoring technologies allows the combined system to produce both pure (Type 2) and ultrapure water from tap. Patented EDI technology and ergonomic remote water dispensers provide consistent water quality and optimized delivery.

Smart Plus

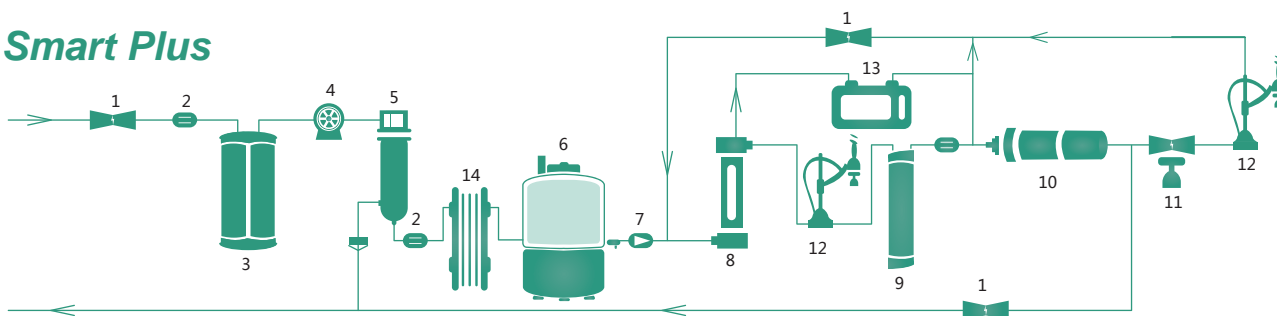

Configuration

<i>SMART PLUS EP System</i>	Smart Plus EP	Smart Plus EPT
Pretreatment module	<input type="checkbox"/>	<input type="checkbox"/>
High pressure pump	<input type="checkbox"/>	<input type="checkbox"/>
Reverse osmosis	<input type="checkbox"/>	<input type="checkbox"/>
Dual wavelength UV-lamp	<input type="checkbox"/>	<input type="checkbox"/>
Ultra-purification cartridge	<input type="checkbox"/>	<input type="checkbox"/>
Ultrafiltration cartridge	<input type="checkbox"/>	<input type="checkbox"/>
EDI Module	<input type="checkbox"/>	<input type="checkbox"/>
Point-of-use filter	<input type="checkbox"/>	<input type="checkbox"/>
Storage tank 30L	<input type="checkbox"/>	<input type="checkbox"/>
Air filter net for tank	<input type="checkbox"/>	<input type="checkbox"/>
UV-lamp sterilizer for water tank	<input type="checkbox"/>	<input type="checkbox"/>
Remote water dispenser with color display	<input type="checkbox"/>	<input type="checkbox"/>
TOC monitoring module	<input type="checkbox"/>	<input type="checkbox"/>

- 1 Solenoid Valve
- 2 Conductivity Sensor
- 3 Pre-treatment Module
- 4 Boost Pump
- 5 RO Module
- 6 Water Tank
- 7 Ball Valve
- 8 Dual Wave UV Cartridge
- 9 Ultra-Purification Module
- 10 Ultra-Filtration Cartridge
- 11 Point-Of-Use Filter
- 12 Remote Water Dispenser
- 13 TOC monitor cell*
- 14 EDI Module

*Applicable for Smart Plus EPT

TOTAL WATER SOLUTIONS

To get the best results from your Smart Plus system, Heal Force recommends feeding it with pure water produced by Smart Plus E water systems



Smart N

Introduction

The Smart N system is a compact solution that combines the production of pure water and ultrapure water in a single unit — eliminating the need for a pretreatment stage upstream of the ultrapure water system.



Configuration

<i>SMART-N System</i>	Smart N15UV	Smart N15VF	Smart N30UV	Smart N30VF
Pretreatment module	<input type="checkbox"/>	<input type="checkbox"/>	<input type="checkbox"/>	<input type="checkbox"/>
High pressure pump	<input type="checkbox"/>	<input type="checkbox"/>	<input type="checkbox"/>	<input type="checkbox"/>
Reverse osmosis	<input type="checkbox"/>	<input type="checkbox"/>	<input type="checkbox"/>	<input type="checkbox"/>
Dual wavelength UV-lamp	<input type="checkbox"/>	<input type="checkbox"/>	<input type="checkbox"/>	<input type="checkbox"/>
Ultra-purification cartridge	<input type="checkbox"/>	<input type="checkbox"/>	<input type="checkbox"/>	<input type="checkbox"/>
Microfiltration cartridge	<input type="checkbox"/>	<input type="checkbox"/>	<input type="checkbox"/>	<input type="checkbox"/>
Ultrafiltration cartridge	<input type="checkbox"/>	<input type="checkbox"/>	<input type="checkbox"/>	<input type="checkbox"/>
Point-of-use filter	<input type="checkbox"/>	<input type="checkbox"/>	<input type="checkbox"/>	<input type="checkbox"/>
Storage tank 30L	<input type="checkbox"/>	<input type="checkbox"/>	<input type="checkbox"/>	<input type="checkbox"/>
Air filter net for tank	<input type="checkbox"/>	<input type="checkbox"/>	<input type="checkbox"/>	<input type="checkbox"/>
Remote water dispenser	<input type="checkbox"/>	<input type="checkbox"/>	<input type="checkbox"/>	<input type="checkbox"/>



Smart N

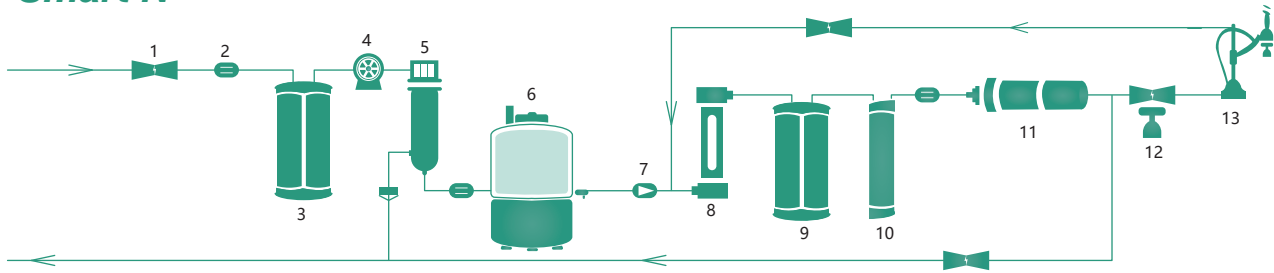

- | | | |
|------------------------|------------------------------|-------------------------------|
| 1 Solenoid Valve | 6 Water Tank | 11 Ultra-Filtration Cartridge |
| 2 Conductivity Sensor | 7 Ball Valve | 12 Point-Of-Use Filter |
| 3 Pre-treatment Module | 8 Dual Wave UV Cartridge | 13 Remote Water Dispenser |
| 4 Boost Pump | 9 Purification Module | |
| 5 RO Module | 10 Ultra-Purification Module | |

Model	Smart N 15UV	Smart N 15VF	Smart N 30UV	Smart N 30VF
Feed Water Requirement				
Source	Tap water	Tap water	Tap water	Tap water
Conductivity*	< 2000us/cm	< 2000us/cm	< 2000us/cm	< 2000us/cm
Hardness**	< 450ppm as CaCO ₃	< 450ppm as CaCO ₃	< 450ppm as CaCO ₃	< 450ppm as CaCO ₃
Pressure	0.05~0.5MPa(7-72psi)	0.05~0.5MPa(7-72psi)	0.05~0.5MPa(7-72psi)	0.05~0.5MPa(7-72psi)
Temperature	5~40 C	5~40 C	5~40 C	5~40 C
Purification Water(Class III)				
Ionic Rejection	>95%	>95%	>95%	>95%
Bacteria Rejection	>99%	>99%	>99%	>99%
Conductivity	1~20us/cm(RO-2 5us/cm)	1~20us/cm(RO-2 5us/cm)	1~20us/cm(RO-2 5us/cm)	1~20us/cm(RO-2 5us/cm)
Productivity Rate	15L/h	15L/h	30L/h	30L/h
Ultrapurification Water(Class I)				
Resistivity At 25 C	18.2MΩ.cm	18.2MΩ.cm	18.2MΩ.cm	18.2MΩ.cm
Conductivity At 25 C	0.055us/cm	0.055us/cm	0.055us/cm	0.055us/cm
TOC Level***	1~5ppb	1~5ppb	1~5ppb	1~5ppb
Endotoxin(Pyrogens)****	N/A	< 0.001EU/ml	N/A	< 0.001EU/ml
Particulate(≥0.02um)	< 1pc/ml	< 1pc/ml	< 1pc/ml	< 1pc/ml
Bacteria***	< 0.1cfu/ml	< 0.1cfu/ml	< 0.1cfu/ml	< 0.1cfu/ml
Rnase / Dnase**	N/A	Free	N/A	Free
Manual dispense flow rate	1.5~2.0L/min	1.5~2.0L/min	1.5~2.0L/min	1.5~2.0L/min
Automatic dispense volume	100~60000ml	100~60000ml	100~60000ml	100~60000ml
Electrical Requirements				
Electrical Voltage	110V/220V±10%	110V/220V±10%	110V/220V±10%	110V/220V±10%
Electrical Frequency	50HZ/60HZ	50HZ/60HZ	50HZ/60HZ	50HZ/60HZ
Packing Information				
Net Weight				
Main units	24kg	24kg	24kg	24kg
Water tank (30L)	7kg	7kg	7kg	7kg
External Dimensions(W×D×H)				
Main units	315×525×570mm	315×525×570mm	315×525×570mm	315×525×570mm
Water tank (30L)	380×380×595mm	380×380×595mm	380×380×595mm	380×380×595mm
Shipping weight				
Main units	37kg	37kg	37kg	37kg
Water tank (30L)	15kg	15kg	15kg	15kg
Shipping Dimensions(W×D×H)				
Main units	525×610×770mm	525×610×770mm	525×610×770mm	525×610×770mm
Water tank (30L)	520×440×615mm	520×440×615mm	520×440×615mm	520×440×615mm

* If feed water quality is poor(Conductivity > 1000us/cm), strengthened pretreatment module and RO-2 type is highly recommended

** When hardness of feed water is high(>450ppm as CaCO₃), 0.5T water soften is recommended

*** Dual wave UV module need to be adopted. Also dependent on feed water, recommended feed TOC < 30ppb

****Ultra-filtration module need to be adopted. Feed water need to be satisfied as above

Smart P

Introduction

Ultrapure water from purified water

The purified water quality required as feedwater

- Tap water subjected to ion exchange, reverse osmosis or distillation
- Optimally, the purified water supplied by a Heal Force Smart E/Smart RO system

The contents of organic and inorganic substances in the feedwater are reduced to values approaching their limits by the serial combination of high-efficiency Heal Force purification technologies.



Smart P

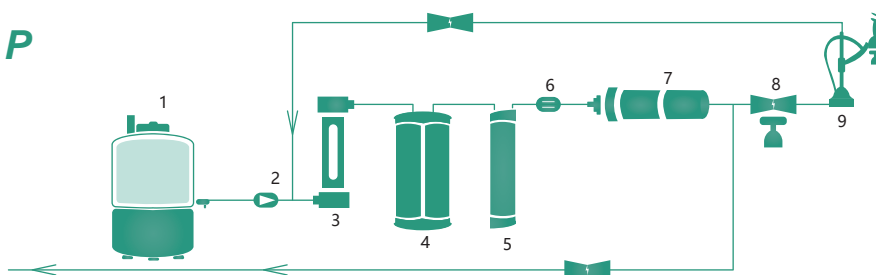

Configuration

- 1 Water Tank
- 2 Ball Valve
- 3 Dual Wave UV Cartridge
- 4 Purification Module
- 5 Ultra-Purification Module
- 6 Conductivity Sensor
- 7 Ultra-Filtration Cartridge
- 8 Point-Of-Use Filter
- 9 Remote Water Dispenser

SMART-P System	SMART-PUV	SMART-PVF
Storage tank 30L	○	○
Dual wavelength UV-lamp	○	○
Ultra-purification cartridge	○	○
Microfiltration cartridge	○	\
Ultrafiltration cartridge	\	○
Point-of-use filter	○	○
Air filter net for tank	○	○
Remote water dispenser	○	○

Model	Smart PUV	Smart PVF
Feed Water Requirement		
Source	RO, Distilled, DI water (Conductivity < 20µs/cm)	RO, Distilled, DI water (Conductivity < 20µs/cm)
Temperature	5~40 °C	5~40 °C
Ultrapurification Water(Class I)		
Resistivity At 25 °C	18.2MΩ.cm	18.2MΩ.cm
Conductivity At 25 °C	0.055us/cm	0.055us/cm
Flow Rate	1.5~2.0L/min	1.5~2.0L/min
TOC Level*	1~5ppb	1~5ppb
Endotoxin(Pyrogens)**	N/A	< 0.001EU/ml
Particulate(≥0.02um)	< 1pc/ml	< 1pc/ml
Bacteria*	< 0.1cfu/ml	< 0.1cfu/ml
Rnase/Dnase**	N/A	Free
Electrical Requirements		
Electrical Voltage	110V/220V±10%	110V/220V±10%
Electrical Frequency	50Hz/60Hz	50Hz/60Hz
Packing Information		
Net Weight		
Main units	18kg	18kg
Water tank (30L)	5kg	5kg
External Dimensions(W×D×H)		
Main units	315×525×570mm	315×525×570mm
Water tank (30L)	380×380×595mm	380×380×595mm
Shipping weight		
Main units	31kg	31kg
Water tank (30L)	13kg	13kg
Shipping Dimensions(W×D×H)		
Main units	525×610×770mm	525×610×770mm
Water tank (30L)	520×440×615mm	520×440×615mm

* Dual wave UV module need to be adopted. Also dependent on feed water, recommended feed TOC < 30ppb

**Ultra-filtration module need to be adopted. Feed water need to be satisfied as above

Smart Mini *Instantly and fresh!*



Introduction

Many laboratories require ultrapure water every day- for HPLC or for other instrumental analyses- but only as small volumes at a time, up to a total of a few liters at the most.

However, this is no reason to do without professional, freshly-prepared ultrapure water and buy expensive HPLC water. After all, with the repeated taking of small volumes from an HPLC water container, the quality of the water and the TOC-value no longer fulfill the specifications. The ultrapure water is no longer ultrapure!

Always fresh. Always available in the volume required. Always with the required quality. And always for only a few cents per liter!

Smart Mini

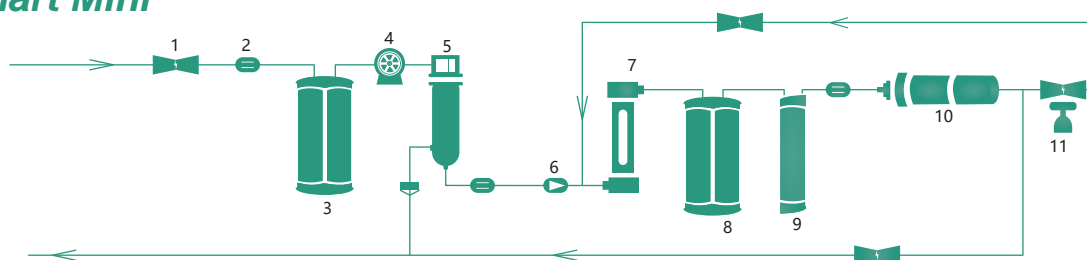

- 1 Solenoid Valve
- 2 Conductivity Sensor
- 3 Pre-treatment Module
- 4 Boost Pump
- 5 RO Module
- 6 Ball Valve
- 7 Dual Wave UV Cartridge
- 8 Purification Module
- 9 Ultra-Purification Module
- 10 Micro-Filtration Cartridge
- 11 Point-Of-Use Filter

Configuration

SMART MINI system	SMART MINI
Pretreatment module	<input type="checkbox"/>
High pressure pump	<input type="checkbox"/>
Reverse osmosis	<input type="checkbox"/>
Dual wavelength UV-lamp	<input type="checkbox"/>
Ultra-purification cartridge	<input type="checkbox"/>
Microfiltration cartridge	<input type="checkbox"/>
Point-of-use filter	<input type="checkbox"/>

Model	Smart Mini
Feed Water Requirement	
Source	Tap water
Conductivity*	< 2000us/cm
Hardness**	< 450ppm as CaCO ₃
Pressure	0.05~0.5MPa(7-72psi)
Temperature	5~40 C
Purification Water(Class III)	
Ionic Rejection	> 95%
Bacteria Rejection	> 99%
Conductivity	1~20us/cm(RO-2 5us/cm)
Productivity Rate	30L/h
Ultrapurification Water(Class I)	
Resistivity At 25 C	18.2MΩ.cm
Conductivity At 25 C	0.055us/cm
TOC Level***	1~5ppb
Endotoxin(Pyrogens)	N/A
Particulate(≥0.02um)	< 1pc/ml
Bacteria***	< 0.1cfu/ml
Rnase / Dnase**	N/A

Ultrapurification Water(Class I)	
Manual dispense flow rate	0.5L/min
Automatic dispense volume	100~60000ml
Electrical Requirements	
Electrical Voltage	110V/220V±10%
Electrical Frequency	50HZ/60HZ
Packing Information	
Net Weight	
Main units	32kg
Water tank	N/A
External Dimensions(W×D×H)	
Main units	315×525×570mm
Water tank	N/A
Shipping weight	
Main units	45kg
Water tank	N/A
Shipping Dimensions(W×D×H)	
Main units	525×610×770mm
Water tank	N/A

* If feed water quality is poor(Conductivity > 1000us/cm), strengthened pretreatment module and RO-2 type is highly recommended

** When hardness of feed water is high(> 450ppm as CaCO₃), 0.5T water soften is recommended

*** Dual wave UV module need to be adopted. Also dependent on feed water, recommended feed TOC < 30ppb

Easy Series *Economical and Convenient*

The model EASY is all-in-one system to produce Type I, II and III pure water. It is specially designed for users whose pure water applications are wide but also concern cost effective aspect.



Easy (Bench Top)

Easy

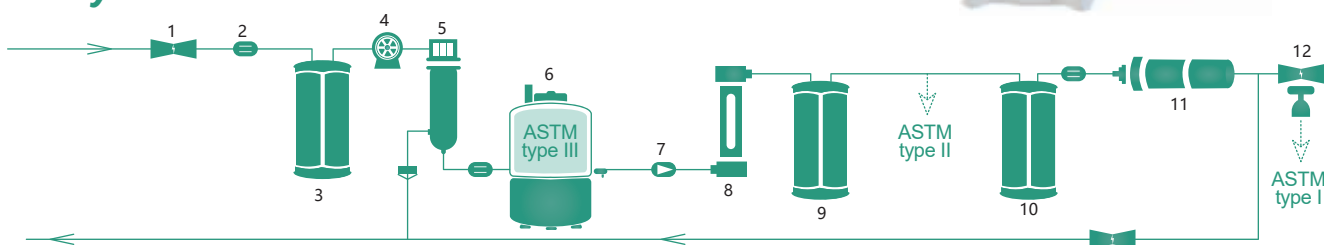

- 1 Solenoid Valve
- 2 Conductivity Sensor
- 3 Pre-treatment Module
- 4 Boost Pump
- 5 RO Module
- 6 Water Tank
- 7 Ball Valve
- 8 Single Wave UV Cartridge
- 9 Purification Module
- 10 Ultra-Purification Module
- 11 Micro-Filtration Cartridge
- 12 Point-Of-Use Filter

Model	EASY(Bench Top)	EASY(Floor Top)
Type	Easy-15/Easy-30	Easy-50/Easy-100
Feed Water Requirement		
Source	Tap water	Tap water
Conductivity*	<2000us/cm	<2000us/cm
Hardness**	<450ppm as CaCO3	<450ppm as CaCO3
Pressure	0.05~0.5MPa(7-72psi)	0.05~0.5MPa(7-72psi)
Temperature	5~40 C	5~40 C
Purification Water(Class III)		
Ionic Rejection	>95%	>95%
Bacteria Rejection	>99%	>99%
Conductivity	1~20us/cm	1~20us/cm
Productivity Rate	15L/h,30L/h	50L/h, 100L/h
High Quality Purification Water(Class II)		
Resistivity At 25 C	10MΩ.cm	10MΩ.cm
TOC	<30ppb	<30ppb
Dissolved Organic	<0.1ppm	<0.1ppm
Ultrapurification Water(Class I)		
Resistivity At 25 C	16~17MΩ.cm	16~17MΩ.cm
Flow Rate	1~1.5L/min	1~1.5L/min
TOC Level(optional with UV)	<30ppb	<30ppb
Particulate(≥0.02um)	<1pc/ml	<1pc/ml
Bacteria	<1cfu/ml	<1cfu/ml
Electrical Requirements		
Electrical Voltage	110V/220V±10%	110V/220V±10%
Electrical Frequency	50Hz/60Hz	50Hz/60Hz
Packing Information		
Net Weight		
Main units	38kg	90kg
Water tank (-/20G)	N/A	10kg
External Dimensions(W×D×H)		
Main units	390×530×500mm	500×460×980mm
Water tank (-/20G)	N/A	380×380×885mm
Shipping weight		
Main units	51kg	112kg
Water tank (-/20G)	N/A	13kg
Shipping Dimensions(W×D×H)		
Main units	515×660×750mm	660×570×1160mm
Water tank (-/20G)	N/A	430×510×895mm

* If feed water quality is poor(Conductivity >1000us/cm), 3 class strengthened pretreatment module and RO-2 type is highly recommended
 ** When hardness of feed water is high(>450ppm as CaCO3), 0.5T water soften tank is recommended

Smart Plus E

Complementary water purification techniques, including state-of-the-art electrodeionization technology, ensuring delivery of constant and reliable quality Type 2 pure water



SMART Plus E

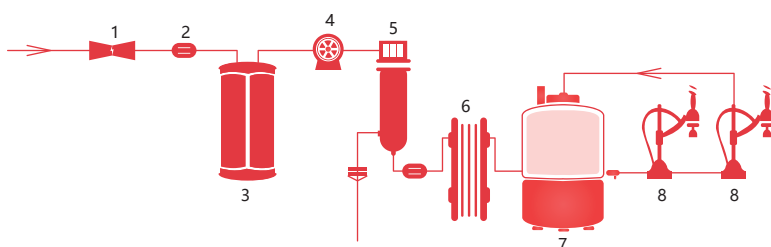

- 1 Solenoid Valve
- 2 Conductivity Sensor
- 3 Pre-treatment Module
- 4 Boost Pump
- 5 RO Module
- 6 EDI Module
- 7 Water Tank
- 8 Remote Water Dispenser

Model	Smart-E
Type	
Feed Water Requirement	
Source	Tap water
Conductivity*	< 2000us/cm
Hardness**	< 450ppm as CaCO ₃
Pressure	0.05~0.5MPa(7-72psi)
Temperature	5~40 C
Purification Water(Class III)	
Ionic Rejection	
Bacteria Rejection	
Conductivity	1~20us/cm
Productivity Rate	30L/h
High Quality Purification Water(Class II)	
Resistivity At 25 C	10MΩ.cm
TOC	< 30ppb
Dissolved Organic	< 0.1ppm
Productivity Rate	15L/h
Electrical Requirements	
Electrical Voltage	110V/220V±10%
Electrical Frequency	50HZ/60HZ
Packing Information	
Net Weight	
Main units	32kg
Water tank (30L)	7kg
External Dimensions(W×D×H)	
Main units	315×525×570mm
Water tank (30L)	380×380×595mm
Shipping weight	
Main units	45kg
Water tank (30L)	15kg
Shipping Dimensions(W×D×H)	
Main units	525×610×770mm
Water tank (30L)	520×440×615mm

* If feed water quality is poor(Conductivity > 1000us/cm), 3 class strengthened pretreatment module and RO-2 type is highly recommended
 ** When hardness of feed water is high(>450ppm as CaCO₃), 0.5T water soften tank is recommended



Smart ROP

Features

Smart ROP Series produce high quality pure water with superior resistivity and low TOC (<30ppb)

Output water can be stored in anti-contamination water tank, and is an ideal solution for routine laboratory application.

Technically combines RO Membrane, deionization and UV Lamp to achieve effective removal on all types of water contaminant.

Built-in UV Lamp is ideal for low bacteria application.



Model	Smart ROP (Bench Top)	ROP (Floor Type)
Type	ROP-15/ROP-30	ROP-50/ROP-100/ROP150
Feed Water Requirement		
Source	Tap water	Tap water
Conductivity*	<2000us/cm	<2000us/cm
Hardness**	<450ppm as CaCO3	<450ppm as CaCO3
Pressure	0.05~0.5MPa(7-72psi)	0.05~0.5MPa(7-72psi)
Temperature	5~40 C	5~40 C
Purification Water(Class III)		
Ionic Rejection	>95%	>95%
Bacteria Rejection	>99%	>99%
Conductivity	1~20us/cm(RO-2 5us/cm)	1~20us/cm(RO-2 5us/cm)
Productivity Rate	15L/h,30L/h	50L/h,100L/h,150L/h
High Quality Purification Water(Class II)		
Resistivity At 25 C	≥10MΩ.cm	≥10MΩ.cm
TOC	≤30ppb	≤30ppb
Dissolved Organic	<0.1ppm	<0.1ppm
Particulate(≥0.02um)	<1pc/ml	<1pc/ml
Bacteria	<1cfu/ml	<1cfu/ml
Flow Rate	1.5~2.0L/min	2~2.5L/min
Electrical Requirements		
Electrical Voltage	110V/220V±10%	110V/220V±10%
Electrical Frequency	50Hz/60Hz	50Hz/60Hz
Packing Information		
Net Weight		
Main units	25kg	90kg
Water tank (30L/60L)	7kg	10kg
External Dimensions(W×D×H)		
Main units	315×525×570mm	660×570×1160mm
Water tank (30L/60L)	380×380×595mm	380×380×885mm
Shipping weight		
Main units	37kg	112kg
Water tank (30L/60L)	13kg	13kg
Shipping Dimensions(W×D×H)		
Main units	525×610×770mm	640×680×1165mm
Water tank (30L/60L)	520×440×615mm	510×430×895mm

* If feed water quality is poor(Conductivity > 1000us/cm), strengthened pretreatment module and RO-2 type is highly recommended
 ** When hardness of feed water is high(>450ppm as CaCO3), 0.5T water soften is recommended

SMART ROP

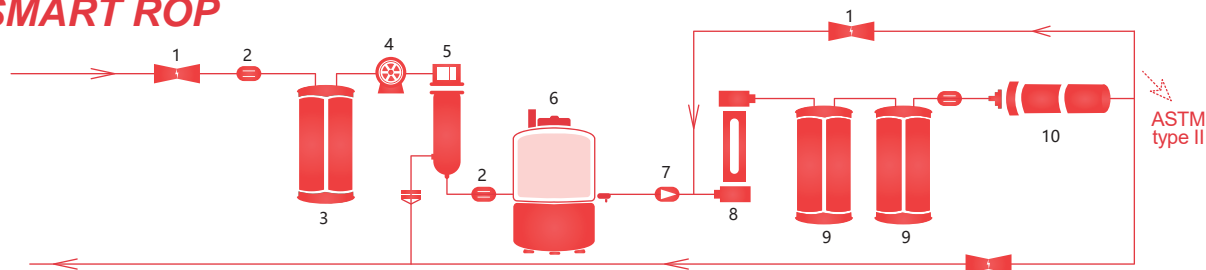

- 1 Solenoid Valve
- 3 Pre-treatment Module
- 5 RO Module
- 7 Ball Valve
- 9 Purification Module
- 2 Conductivity Sensor
- 4 Boost Pump
- 6 Water Tank
- 8 Single Wave UV Cartridge
- 10 Micro-Filtration Cartridge

Smart RO

Features

Intelligent microprocessor control

High precision resistance sensor

Large LCD display shows system temperature, conductivity and resistivity, water tank level, water ration and other operation information

Automatic RO membrane rinse and flow limitation design improve cleaning result, and extend RO membrane' s lifespan

Heal Force' s reservoirs are designed with smooth sides and vented filtration maintain consistent purity of stored water and provide effective protection against airborne contaminants.



Model	Smart RO (Bench Top)	RO (Floor Type)
Type	RO-15/RO-30	RO-50/RO-100/RO-150
Feed Water Requirement		
Source	Tap water	Tap water
Conductivity*	< 2000us/cm	< 2000us/cm
Hardness**	< 450ppm as CaCO3	< 450ppm as CaCO3
Pressure	0.05~0.5MPa(7-72psi)	0.05~0.5MPa(7-72psi)
Temperature	5~40 C	5~40 C
Purification Water(Class III)		
Ionic Rejection	> 95%	> 95%
Bacteria Rejection	> 99%	> 99%
Conductivity	1~20us/cm(RO-2 5us/cm)	1~20us/cm(RO-2 5us/cm)
Productivity Rate	15L/h,30L/h	50L/h,100L/h,150L/h
Electrical Requirements		
Electrical Voltage	110V/220V±10%	110V/220V±10%
Electrical Frequency	50HZ/60HZ±10%	50HZ/60HZ±10%
Packing Information		
Net Weight		
Main units	21kg	74kg
Water tank (30L/60L)	5kg	10kg
External Dimensions(W×D×H)		
Main units	315×525×570mm	660×570×1160mm
Water tank (30L/60L)	380×380×595mm	380×380×885mm
Shipping weight		
Main units	34kg	96kg
Water tank (30L/60L)	13kg	13kg
Shipping Dimensions(W×D×H)		
Main units	525×610×770mm	640×680×1165mm
Water tank (30L/60L)	520×440×615mm	510×430×895mm

* If feed water quality is poor(Conductivity > 1000us/cm), strengthened pretreatment module and RO-2 type is highly recommended

** When hardness of feed water is high(> 450ppm as CaCO3), 0.5T water soften is recommended

SMART RO

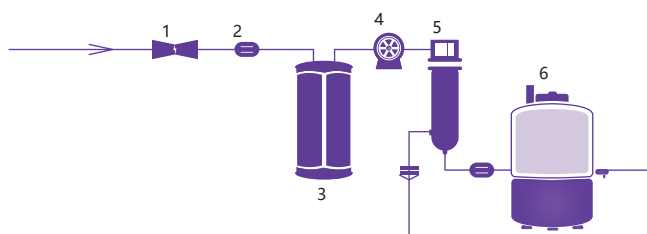

- 1 Solenoid Valve
- 2 Conductivity Sensor
- 3 Pre-treatment Module
- 4 Boost Pump
- 5 RO Module
- 6 Water Tank



Born for clinical analyzers

Smart ROB, PUREFORCE ROE are designed to provide water for clinical analyzers specified to Clinical Laboratory Reagent Water standard (formally Clinical Laboratory Standards Institute Type). Our product range delivers consistent water quality feeding a single clinical analyzer, large automated analyzers and multiple analyzers on a distribution loop.

To help you choose the most suitable system for your clinical analyzer requirements, we have developed the reference table below. Our Heal Force team works together with project managers, installation engineers, facilities managers, and clinical scientists to provide help and expertise at all stages.

Model	Water quality (MΩ.cm)	Water quality (CFU/ml)	Max. water rate (liters/hr)	Max. flow rate (liters/hr)	Max. feed loop length (meter)	Application
Smart ROB 15/30	>10	\	15,30	120~150	\	Single clinical analyzer
Smart ROB 15R/30R	>10	<1	15,30	120~150	\	Single clinical analyzer
Smart ROB 50/100/150	>10	\	50,100,150	120~150 (500~800*)	20~30	High volume single clinical analyzer
Smart ROB 50R/100R/150R	>10	<1	50,100,150	120~150 (500~800*)	20~30	High volume single clinical analyzer
Pureforce ROE 30/70/100	>10	<1	30,70,100	120~180 (500~800*)	50	High volume single clinical analyzer or multiple clinical analyzers
Pureforce ROE 150/300	>10	<1	150,300	800~1300	100	Multiple clinical analyzers

*Upgradable with 350 liters water tank

Smart ROB

ROB system can produce CAP/CLSI Type I reagent water for clinical analyzer. It enables direct connection and operation online. Independent manual control water outlet can be used for additional applications.



Maximum compability

- ROB water purification systems can be applied to prepare pure water solution for a series of biochemical analyzers, including TOSHIBA, OLYMPUS, HITACHI, ROCHE, MINDRAY and so on. Furthermore, our
- technical and application specialists are always available to answer any questions, as well as providing friendly, expert advice on choosing the most suitable water purification systems.

High volume solution

Optional tanks with 25L purification resin can meet heavier water usage, decreasing change frequency of consumables.

Special emphasis on bacterial containment

On the basis of ROB, the model ROB-R further upgrades the system. It possesses a re-circulation function to always ensure a desirable pure water quality. UV, Micro-filtration technologies and easy sanitization ensures optimal bacteria purity of less than 1CFU/ml.

Bypass function to save your worry

An emergency bypass prevents downtime by providing an uninterrupted supply of pure water to the analyzer at all time. We understand that downtime can not be allowed in the clinical laboratory.



Smart ROB

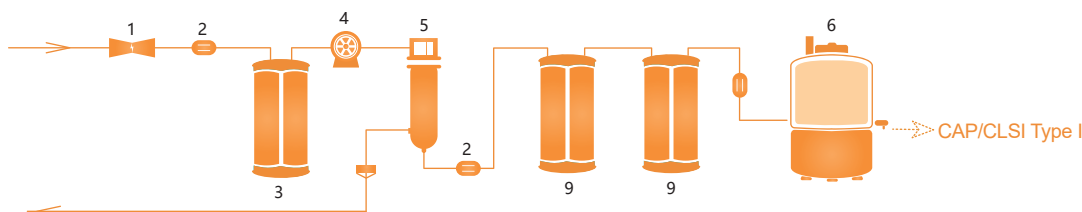

- 1 Solenoid Valve
- 2 Conductivity Sensor
- 3 Pre-treatment Module
- 4 Boost Pump
- 5 RO Module
- 6 Water Tank

Smart ROB-R

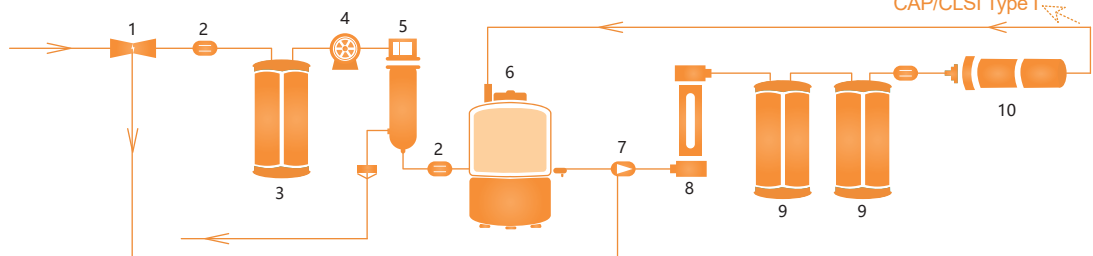

- 7 Ball Valve
- 8 Single Wave UV Cartridge
- 9 Purification Module
- 10 Micro-Filtration Cartridge

Model	Smart ROB/ROB-R (Bench Top)	ROB/ROB-R (Floor Type)
Type	ROB-15/ROB-30/ROB-R15/ROB-R30	ROB-50/ROB-100/ROB-150/ROB-R50/ROB-R100/ROB-R150
Productivity Rate	15L/h,30L/h	50L/h,100L/h,150L/h
Feed Water Requirement		
Source	Tap water	Tap water
Conductivity*	< 2000us/cm	< 2000us/cm
Hardness**	< 450ppm as CaCO3	< 450ppm as CaCO3
Pressure	0.1~0.5MPa	0.1~0.5MPa
Temperature	5~40 C	5~40 C
High Quality Purification Water(Class II)		
Resistivity At 25 C	≥10MΩ.cm	≥10MΩ.cm
TOC	-/< 30ppb	-/< 30ppb
Dissolved Organic	-/< 0.1ppm	-/< 0.1ppm
Particulate(≥0.02um)	-/< 1pc/ml	-/< 1pc/ml
Bacteria	-/< 1cfu/ml	-/< 1cfu/ml
Flow Rate	1.0~1.5L/min	1.5~2.0L/min
Electrical Requirements		
Electrical Voltage	110V/220V±10%	110V/220V±10%
Electrical Frequency	50Hz/60Hz	50Hz/60Hz
Packing Information		
Net Weight		
Main units	25kg	90kg
Water tank	5kg	10kg
External Dimensions(W×D×H)		
Main units	315×525×570mm	500×460×980mm
Water tank	380×380×595mm	380×380×885mm
Shipping weight		
Main units	37kg	112kg
Water tank	13kg	13kg
Shipping Dimensions(W×D×H)		
Main units	525×610×770mm	660×570×1160mm
Water tank	520×440×615mm	510×430×895mm

* If feed water quality is poor(Conductivity > 1000us/cm), 3 class strengthened pretreatment module and RO-2 type is highly recommended

** When hardness of feed water is high(> 450ppm as CaCO3), 0.5T water soften tank is recommended

Pureforce Series ROE (30,70,100L/h)



Introduction

Heal Force has developed ROE model, specially for high demanding water solution in research laboratories. Incorporating with Electrodeionization module, ROE can continuously supply type II purified water.

Push-to-sterilize

Just a simple key press to sterilize reverse osmosis, recirculation pumpline and water tank, ensuring water quality

Touch screen control

- 8.0 inches colored display for multi-parameters
- Intelligent control with man-machine interaction
- Filter life indicator with alarm function in time

Internal 60L water tank

- Water tank is integrated into the main structure to save your valuable laboratory space
- The water reservoir is made through cylindrical mold and blow molding process to avoid the generation of velum
- PE material ensure low extractives
- Optional UV lamp and vented filter maintain consistent purity of stored water

EDI module

- Resins are continuously regenerated by the electrical current and are never exhausted
- Low operating cost, low energy consumption and low maintenance

Backup

Duplex operation (i.e. two linked Pureforce ROB units) to provide an even greater operational contingency that avoids a single point of failure

Heal Force has installed thousands of systems globally. Whether you require systems that feed a single small analyzer, a large automated analyzer, or even multiple analyzers throughout an entire building, we can provide tailored solutions meeting all specified clinical analyzer requirements economically, and on budget.

Additional features

- Strengthened purification cartridges - Loaded with PP cotton, active carbon, soften resin meet large volume requirement, optimizing the following purification efficiency
- Unique Reverse Osmosis - Flow restriction design with automated forward and backward rinse increases lifespan of the module by 50%
- Patented resistivity meter - Compact type meters with low cell constant (0.01cm-1) and automatic temperature compensation make the value meaningful
- Simple modular design - Standard modular consumables and accessories facilitate daily operation and maintenance.

Pureforce ROE

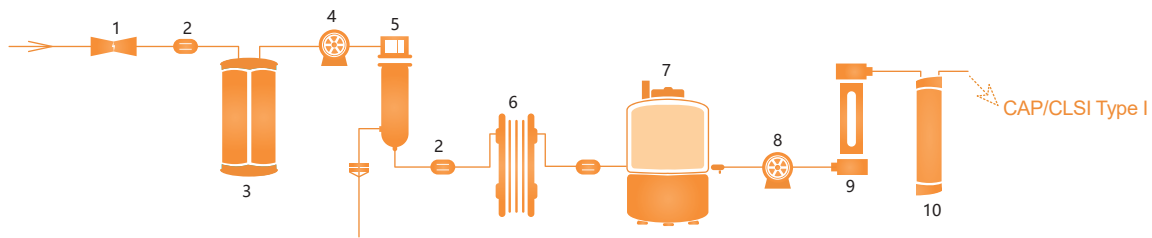

- | | | |
|------------------------|--------------|------------------------------|
| 1 Solenoid Valve | 5 RO Module | 8 Ball Valve |
| 2 Conductivity Sensor | 6 EDI Module | 9 Single Wave UV Cartridge |
| 3 Pre-treatment Module | 7 Water Tank | 10 Micro-Purification Module |
| 4 Boost Pump | | |

Model	Pureforce ROE	Pureforce ROE	Pureforce ROE
Type	ROE-30	ROE-70	ROE-100
Productivity Rate	30L/h	70L/h	100L/h
Feed Water Requirement			
Source	Tap water	Tap water	Tap water
Conductivity*	< 2000us/cm	< 2000us/cm	< 2000us/cm
Hardness**	< 450ppm as CaCO3	< 450ppm as CaCO3	< 450ppm as CaCO3
Pressure	0.1~0.5MPa	0.1~0.5MPa	0.1~0.5MPa
Temperature	5~40 C	5~40 C	5~40 C
High Quality Purification Water(Class II)			
Resistivity At 25 C	≥10MΩ.cm	≥10MΩ.cm	≥10MΩ.cm
TOC	≤30ppb	≤30ppb	≤30ppb
Dissolved Organic	< 0.1ppm	< 0.1ppm	< 0.1ppm
Particulate(≥0.02um)	< 1pc/ml	< 1pc/ml	< 1pc/ml
Bacteria	< 1cfu/ml	< 1cfu/ml	< 1cfu/ml
Flow Rate	3.0~4.0L/min	3.0~4.0L/min	3.0~4.0L/min
Electrical Requirements			
Electrical Voltage	110V/220V±10%	110V/220V±10%	110V/220V±10%
Electrical Frequency	50Hz/60Hz	50Hz/60Hz	50Hz/60Hz
Packing Information			
Net Weight			
Main units	120kg	120kg	120kg
External Dimensions(W×D×H)			
Main units	650×715×1650mm	650×715×1650mm	650×715×1650mm
Shipping weight			
Main units	150kg	150kg	150kg
Shipping Dimensions(W×D×H)			
Main units	735×780×1790	735×780×1790	735×780×1790

* If feed water quality is poor(Conductivity > 1000us/cm), 3 class strengthened pretreatment module and RO-2 type is highly recommended

** When hardness of feed water is high(>450ppm as CaCO3), 0.5T water soften tank is recommended

Pureforce Series ROE (150,300,500L/h)

Pureforce ROE sets the standards in quality, design and innovation that comes from a heritage of many years of experience in centralized distribution of laboratory water. Pureforce ROE offers high quality feed water for multiple automatic biochemical analyzers simultaneously through loop distribution

Feature

0.86m²

- Highly integrated water purification system containing pretreatment module, RO membrane, water tank ect. inside.
- It occupies only 0.86 square meters - Maximum space saving

Internal 350L water tank

- Water tank is integrated into the main structure to save your valuable laboratory space
- The water reservoir is made through cylindrical mold and blow molding process to avoid the generation of velum
- Standard vented filter prevents microorganism maintains consistent purity of stored water
- 5-level float sensor control for automatic water production and shutdown

8.0-inch touch screen

- Intelligent control with man-machine interaction
- 8.0 inches colored touch screen for multi-parameter display with consumable life indicator
- Two different water supply mode - direct mode & recirculation mode
- Three recirculation modes (day, night, holiday) to prevent bacteria growth in the distribution loop

Dual-system backup control module (optional)

Two Biopure ROE systems can supply high quality water at the same time to fulfill peak water usage. The control module can shift to one system supply mode for daily maintenance.

Additional

Prefilter- Save worry, save time, save money

Prefilter with antiscaling agent replaces quartz sand to eliminate sand, silt, clay and other suspended particles which may cause interference to the following purification steps

Multiple valve- automatic operation

Active carbon tank incorporate multiple valve to control the forward and backward rinsing automatically.

Resistivity meter- Patented low cell constant (0.01cm⁻¹)

Low cell constant (0.01cm⁻¹) with automatic temperature compensation (0.1 °C resolution) ensures optimum measurement accuracy of low ionic contamination

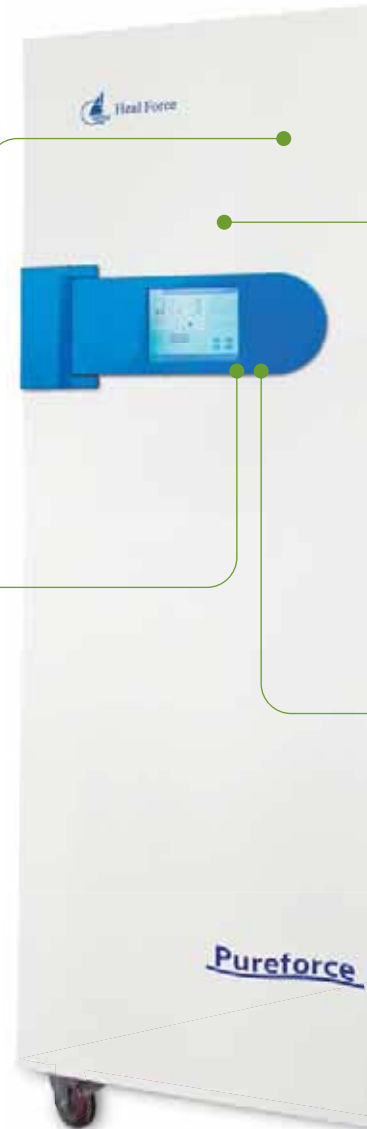



Push-to-sterilize

Just a simple key press to sterilize reverse osmosis, recirculation pipeline and water tank, ensuring water quality

Quiet and energy-saving pump

Self-induced high pressure pump with low noise and minimal vibration ensures water flow varies less than 10% when supply water pressure changes 50%, making the pressure of distribution loop stable and RO, EDI module safe

Anti scaling EDI module

- Adopt reliable EDI module - no exchange of spent resins for low operating cost
- Unique anti scaling design for longer life span

Remote monitoring and control system (Optional)

You can not only monitor the real time working status and parameters, but also control the system from a distance. Data storage and print, USB interface configurations promote management efficiency, and control cost. It is perfectly designed for your Smart laboratory.

Model	Production rate	Water quality	External Dimensions(WxDxH)	Electrica
ROE150	150L/h	≥10MΩ	1040×800×1850mm	AC220V/2.5KW
ROE300	300L/h	≥10MΩ	1040×800×1850mm	AC220V/2.5KW
ROE2-150	150L/h	≥10MΩ	1040×800×1850mm	AC220V/2.5KW
ROE500	500L/h	≥10MΩ	1040×800×1850mm	AC220V/2.5KW
Feed Water Requirement	Tap water (Conductivity<400us/cm); Feeding Pressure:0.1~0.4MPa;Temperature:5~40 C			
Ionic Rejection	RO≥98%; RO2≥99%			
Bacteria Rejection	≥99%			
Flow rate	An instantaneous demand of up to 800~1300L/h, water supply pressure: 0.15~0.35MPa			

Pureforce ROE

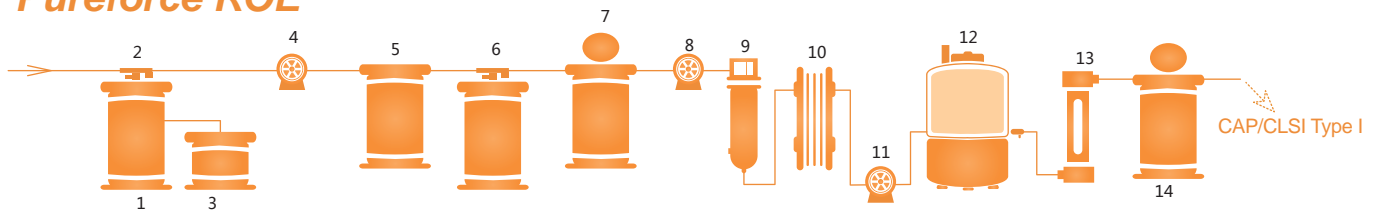

- 1 Soften system (Optional)
- 2 Electronic multi-way valve
- 3 Salt tank (Optional)
- 4 Raw water feeding pump

- 5 Pre-filter
- 6 Active carbon filter
- 7 Security filter
- 8 High pressure pump

- 9 RO module
- 10 EDI
- 11 Supply pump
- 12 Built-in high pure water tank

- 13 UV lamp
- 14 Point-of-use filter

CAP/CLSI Type I



Designed to meet the latest medical standards

EN15883, HTM2030/2031, NHS MESC52, MDA/HIS, ISO 15883 part 4, EN285

Introduction

Cleaning and sterilizing reusable medical equipment is becoming increasingly regulated by industry guidelines and international standards, as concern grows over infection control in hospitals

When high purity water is required for healthcare applications, Heal Force offers a choice of systems with the flexibility to meet your needs.

General applications:

From small bench-top washer disinfectors and autoclaves and single endoscope reprocessor installations, to large or multiple automated endoscope reprocessors and washer disinfectant installations

Product Finder

Model	Water quality (µs/cm)	Max. water rate (liters/hr)	Max. flow rate (liters/min)	Max. feed loop length (meter)	Application (µs/cm)
Smart RO 15/30	<20	15,30	1~2	50	Small bench-top washer disinfectors and autoclaves
RO 50/100/150	<20	50,100,150	8~10*	50	Small washer disinfectors and endoscope reprocessors
RO 150/300/500	<20	150,300,500	15~25	100**	Large or multiple automated endoscope reprocessors and/or washer disinfectors

*Upgradable with 350 liters water tank

**Maximum 3 floors

Smart RO

Smart RO 15/30

Provides 15 or 30 liters/hr of purified water at a price that is comparable to compliant purified bottled water without the hassle of continual ordering and storage. The SMART 15/30 is cost-effective and is more environmentally friendly than traditional distillation units. The unit's compact size allows it to be positioned on or under a bench, wall mounted or fitted into a cabinet.

RO 50/100/150

Cost-effectively provides 50,100,150 liters/hr of compliant purified water. The SMART 50/100/150 ensures a continual supply of purified water for installations such as single washer disinfectors and endoscope reprocessors.



Model	Smart RO (Bench Top)	RO (Floor Type)
Type	RO-15/RO-30	RO-50/RO-100/RO-150
Feed Water Requirement		
Source	Tap water	Tap water
Conductivity*	<2000us/cm	<2000us/cm
Hardness**	<450ppm as CaCO3	<450ppm as CaCO3
Pressure	0.05~0.5MPa(7-72psi)	0.05~0.5MPa(7-72psi)
Temperature	5~40 C	5~40 C
Purification Water(Class III)		
Ionic Rejection	>95%	>95%
Bacteria Rejection	>99%	>99%
Conductivity	1~20us/cm(RO-2 5us/cm)	1~20us/cm(RO-2 5us/cm)
Productivity Rate	15L/h,30L/h	50L/h,100L/h,150L/h
Electrical Requirements		
Electrical Voltage	110V/220V±10%	110V/220V±10%
Electrical Frequency	50HZ/60HZ±10%	50HZ/60HZ±10%
Packing Information		
Net Weight		
Main units	21kg	74kg
Water tank (30L/60L)	5kg	10kg
External Dimensions(W×D×H)		
Main units	315×525×570mm	660×570×1160mm
Water tank (30L/60L)	380×380×595mm	380×380×885mm
Shipping weight		
Main units	34kg	96kg
Water tank (30L/60L)	13kg	13kg
Shipping Dimensions(W×D×H)		
Main units	525×610×770mm	640×680×1165mm
Water tank (30L/60L)	520×440×615mm	510×430×895mm

* If feed water quality is poor(Conductivity >1000us/cm), strengthened pretreatment module and RO-2 type is highly recommended

** When hardness of feed water is high(>450ppm as CaCO3), 0.5T water soften is recommended

SMART RO

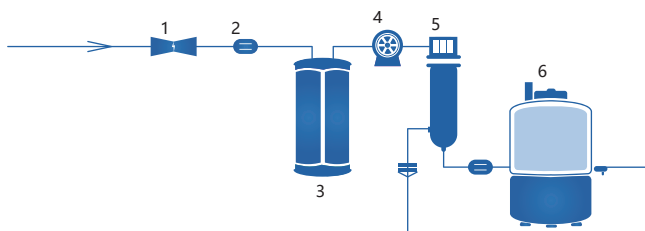

- 1 Solenoid Valve
- 2 Conductivity Sensor
- 3 Pre-treatment Module
- 4 Boost Pump
- 5 RO Module
- 6 Water Tank

Pureforce Series RO (150,300,500L/h)

Pureforce RO150/300/500 systems cost-effectively provide high quality feed water at rates of 150 to 500 liters/hr to large or multiple automated endoscope reprocessors and washer disinfectant installations

Feature

0.86m²

- Highly integrated water purification system containing pretreatment module, RO membrane, water tank ect. inside.
- It occupies only 0.86 square meters - Maximum space saving

In-built 350L reservoir

- Water tank is integrated into the main structure to save your valuable laboratory space
- The water reservoir is made through cylindrical mold and blow molding process to avoid the generation of velum
- Standard vented filter prevents microorganism maintains consistent purity of stored water
- A compact design with an in-built wrap-around reservoir ensures a minimal amount of precious hospital or surgery space is occupied.

8.0-inch touch screen

- Pureforce RO is easy and cost-effective to operate and a self-disinfection program contributes towards straightforward maintenance.
- Peace of mind is provided by a unique E-key, which restricts access to the most critical functions.

Dual-system backup control module (optional)

Two Pureforce RO systems can supply high quality water at the same time to fulfill peak water usage. The control module can shift to one system supply mode for daily maintenance.

Additional

Pre-filter* - Save worry, save time, save money

Pre-filter with antiscalant agent replaces quartz sand to eliminate sand, silt, clay and other suspended particles which may cause interference to the following purification steps

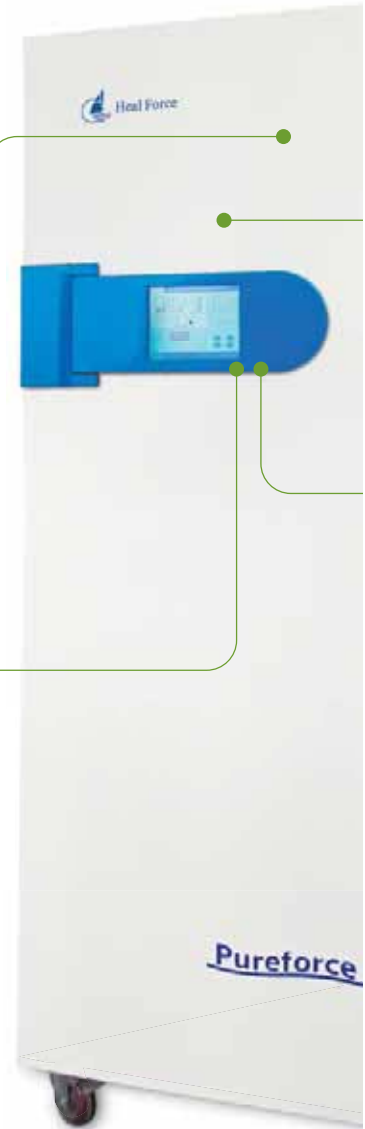

* Applicable for Pureforce RO500



Push-to-sterilize

Just a simple key press to sterilize reverse osmosis, recirculation pipeline and water tank, ensuring water quality



Quiet and energy-saving pump

Self-induced high pressure pump with low noise and minimal vibration ensures water flow varies less than 10% when supply water pressure changes 50%, making the pressure of distribution loop stable and RO safe



Remote monitoring and control system (Optional)

You can not only monitor the real time working status and parameters, but also control the system from a distance. Data storage and print, USB interface configurations promote management efficiency, and control cost. It is perfectly designed for your Smart laboratory.

Water quality is maintained by:

Regularly sanitizing and validating rinse water systems to ensure they continue to meet the water specification

Model	Production rate	Water quality	External Dimensions(WxDxH)	Electrica
RO150	150L/h	<20µs/cm	1040x800x1850mm	AC220V/2.5KW
RO300	300L/h	<20µs/cm	1040x800x1850mm	AC220V/2.5KW
RO2-150	150L/h	<20µs/cm	1040x800x1850mm	AC220V/2.5KW
RO500	500L/h	<20µs/cm	1040x800x1850mm	AC220V/2.5KW
Feed Water Requirement	Tap water (Conductivity<400us/cm); Feeding Pressure:0.1~0.4MPa;Temperature:5~40 C			
Ionic Rejection	RO≥98%; RO2≥99%			
Bacteria Rejection	≥99%			
Flow rate	An instantaneous demand of up to 800~1300L/h, water supply pressure: 0.15~0.35MPa			

Pureforce RO

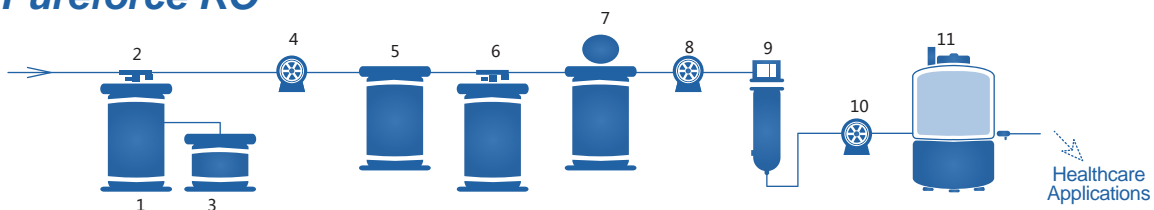

- 1 Soften system (Optional)
- 2 Electronic multi-way valve
- 3 Salt tank (Optional)

- 4 Raw water feeding pump
- 5 Pre-filter
- 6 Active carbon filter

- 7 Security filter
- 8 High pressure pump
- 9 RO module

- 10 Supply pump
- 11 Built-in high pure water tank

Healthcare Applications



Animal Watering Solutions



Introduction

Animal watering is done using either drinking bottles placed in each cage, or an automatic watering system. The US National Research Council Guide for the Care and Use of Laboratory Animals is recognized in many countries as the standard for quality animal care and use.

Challenges and Requirement



Time & Seasons

While ordinary tap water can be used for animal watering in some cases, the fact that its composition may vary with time and with the seasons can be a problem for researchers.



Geographical Locations

Tap water variations may also be an issue when comparing the results of research performed in laboratories located in different geographical locations. In order to obtain consistent and reliable experimental results, it is important to provide laboratory animals with drinking water of consistent quality.



Disease Model

In addition, some animals (for example, immuno-compromised animals) or disease models are known to be very sensitive to their environment and require very pure water.

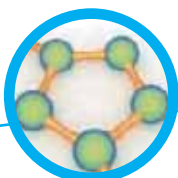

Organics

Some organics, such as pesticides, endocrine disruptors, etc. which may be present in tap water, can affect the health of laboratory animals and interfere with the research being conducted. In addition, in the presence of chlorine, organics may form disinfection by-products (DBP), some of which are thought to be carcinogenic or affect reproduction.

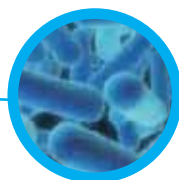

Bacteria

Bacteria can cause serious health problems to the animals and are a main concern in animal facilities. Immuno-compromised and transgenic animals are especially sensitive to bacterial contamination. *Pseudomonas aeruginosa*, for example, is an opportunistic pathogen commonly found in water, and may affect the health of vulnerable animals.



Heavy metals

High levels of heavy metals (copper, iron, zinc, lead ...) can be toxic for health-compromised animals. These metals can be leached from piping. Ions and metals present in water can be greatly removed by reverse osmosis.

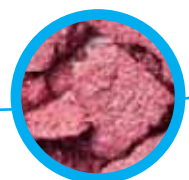

Hardness and particles

Hard water deposits and particles can damage the valves of automated watering systems, and cause leaks inside the animal cages. They will also increase the need for system maintenance.



Smart ROA

Features

Animals have access to clean, fresh water on demand – 24 hours a day, 7 days a week.

Saves time and labor by reducing or eliminating your reliance on water bottles, allowing you to utilize staff in smarter ways.

Reservoirs are designed with smooth sides and vented filtration maintain no dead legs or places for bacteria to hide.

Complete monitoring of the automated watering system verifies performance and keeps all parameters under control, safeguarding your research animals and studies.

Model	RO (Floor Type)	RO (Floor Type)	RO (Floor Type)	RO (Floor Type)
Type	RO-30	RO-50	RO-100	RO-150
Feed Water Requirement				
Source	Tap water	Tap water	Tap water	Tap water
Conductivity*	< 2000us/cm	< 2000us/cm	< 2000us/cm	< 2000us/cm
Hardness**	< 450ppm as CaCO3	< 450ppm as CaCO3	< 450ppm as CaCO3	< 450ppm as CaCO3
Pressure	0.05~0.5MPa(7-72psi)	0.05~0.5MPa(7-72psi)	0.05~0.5MPa(7-72psi)	0.05~0.5MPa(7-72psi)
Temperature	5~40 C	5~40 C	5~40 C	5~40 C
Purification Water				
Ionic Rejection	>95%	>95%	>95%	>95%
Bacteria Rejection	>99%	>99%	>99%	>99%
Conductivity	1~20us/cm	1~20us/cm	1~20us/cm	1~20us/cm
RO Productivity	30L/h	50L/h	100L/h	150L/h
Particulate(≥0.02um)	< 1pc/ml	< 1pc/ml	< 1pc/ml	< 1pc/ml
Bacteria	< 1cfu/ml	< 1cfu/ml	< 1cfu/ml	< 1cfu/ml
Flow Rate	1.6~2.4L/min	1.6~2.4L/min	1.6~2.4L/min	1.6~2.4L/min
Electrical Requirements				
Electrical Voltage	110V/220V±10%	110V/220V±10%	110V/220V±10%	110V/220V±10%
Electrical Frequency	50HZ/60HZ±10%	50HZ/60HZ±10%	50HZ/60HZ±10%	50HZ/60HZ±10%
Packing Information				
Net Weight				
Main units	74kg	74kg	74kg	74kg
Water tank (30L/60L)	10kg	10kg	10kg	10kg
External Dimensions(W×D×H)				
Main units	660×570×1160mm	660×570×1160mm	660×570×1160mm	660×570×1160mm
Water tank (30L/60L)	380×380×885mm	380×380×885mm	380×380×885mm	380×380×885mm
Shipping weight				
Main units	96kg	96kg	96kg	96kg
Water tank (30L/60L)	13kg	13kg	13kg	13kg
Shipping Dimensions(W×D×H)				
Main units	640×680×1165mm	640×680×1165mm	640×680×1165mm	640×680×1165mm
Water tank (30L/60L)	510×430×895mm	510×430×895mm	510×430×895mm	510×430×895mm

* If feed water quality is poor(Conductivity > 1000us/cm), strengthened pretreatment module and RO-2 type is highly recommended

** When hardness of feed water is high(> 450ppm as CaCO3), 0.5T water soften is recommended

SMART ROA

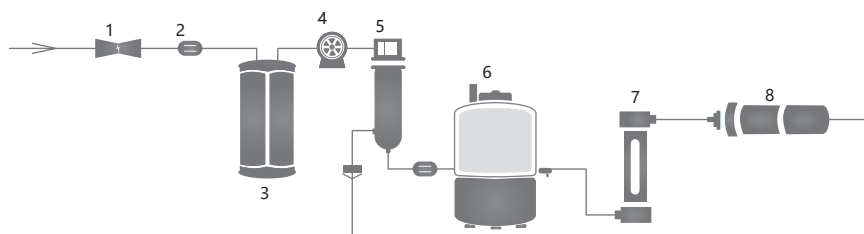

- 1 Solenoid Valve
- 2 Conductivity Sensor
- 3 Pre-treatment Module
- 4 Boost Pump
- 5 RO Module
- 6 Water Tank
- 7 Single Wave UV Cartridge
- 8 Micro-Filtration Cartridge

Pureforce Series ROA (150,300,500L/h)

Pureforce ROA is capable of providing water to practically every animal in the vivarium. Whether you have mice, rats, dogs, guinea pigs, non-human primates, hogs, birds, cats, or rabbits, we have tailored solutions to suit the species.

Feature

0.86m²

- Highly integrated water purification system containing pretreatment module, RO membrane, water tank ect. inside.
- It occupies only 0.86 square meters - Maximum space saving

Internal 350L water tank

- Water tank is integrated into the main structure to save your valuable laboratory space
- The water reservoir is made through cylindrical mold and blow molding process to avoid the generation of velum
- Standard vented filter prevents microorganism maintains consistent purity of stored water
- 5-level float sensor control for automatic water production and shutdown

8.0-inch touch screen

- Intelligent control with man-machine interaction
- 8.0 inches colored touch screen for multi-parameter display with consumable life indicator
- Two different water supply mode - direct mode & recirculation mode
- Three recirculation modes (day, night, holiday) to prevent bacteria growth in the distribution loop

Dual-system backup control module (optional)

Two Pureforce ROA systems can supply high quality water at the same time to fulfill peak water usage. The control module can shift to one system supply mode for daily maintenance.

Additional

Prefilter* - Save worry, save time, save money

Prefilter with antiscaling agent replaces quartz sand to eliminate sand, silt, clay and other suspended particles which may cause interference to the following purification steps

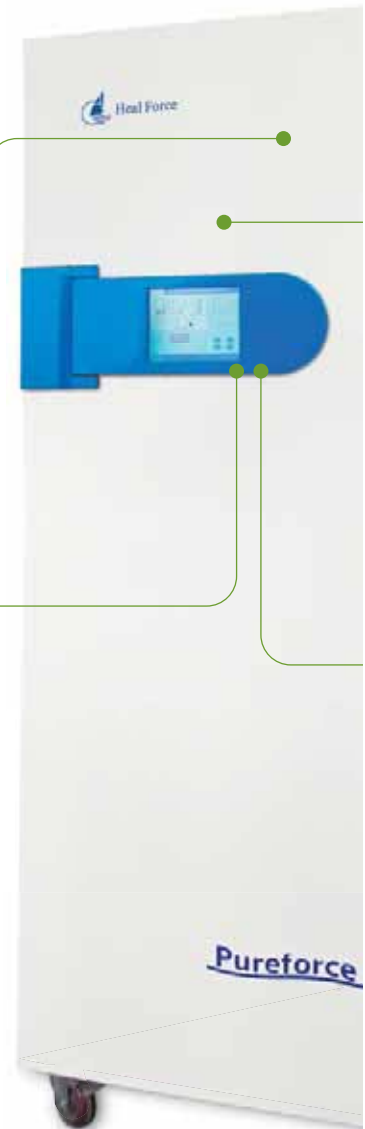

* Applicable for Pureforce ROA500

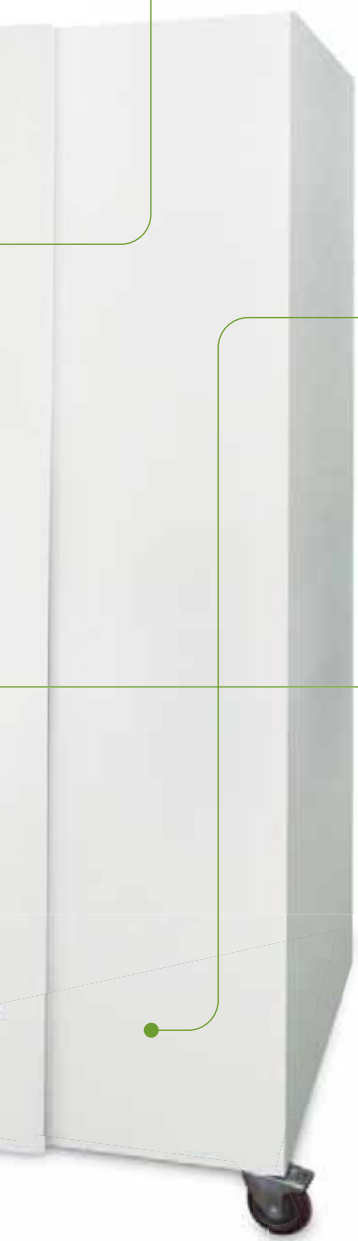

Push-to-sterilize

Just a simple key press to sterilize reverse osmosis, recirculation pipeline and water tank, ensuring water quality



Quiet and energy-saving pump

Self-induced high pressure pump with low noise and minimal vibration ensures water flow varies less than 10% when supply water pressure changes 50%, making the pressure of distribution loop stable and RO safe



Remote monitoring and control system (Optional)

You can not only monitor the real time working status and parameters, but also control the system from a distance. Data storage and print, USB interface configurations promote management efficiency, and control cost. It is perfectly designed for your Smart laboratory.

Model	Production rate	Conductivity	Bacteria	External Dimensions(WxDxH)	Electrica
ROA150	150L/h	<20µs/cm	<1CFU	1040×800×1850mm	AC220V/2.5KW
ROA300	300L/h	<20µs/cm	<1CFU	1040×800×1850mm	AC220V/2.5KW
ROA2-150	150L/h	<20µs/cm	<1CFU	1040×800×1850mm	AC220V/2.5KW
ROA500	500L/h	<20µs/cm	<1CFU	1040×800×1850mm	AC220V/2.5KW
Feed Water Requirement	Tap water (Conductivity<400us/cm); Feeding Pressure:0.1~0.4MPa;Temperature:5~40 C				
Ionic Rejection	RO≥98%; RO2≥99%				
Bacteria Rejection	≥99%				
Flow rate	An instantaneous demand of up to 800~1300L/h, water supply pressure: 0.15~0.35MPa				

Pureforce ROA

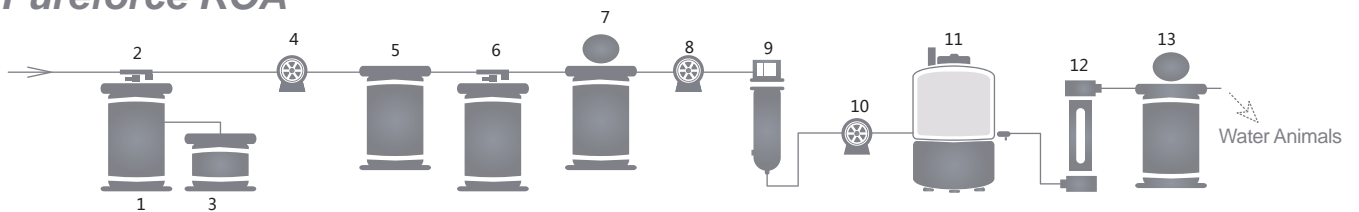

- 1 Soften system (Optional)
- 2 Electronic multi-way valve
- 3 Salt tank (Optional)
- 4 Raw water feeding pump

- 5 Pre-filter
- 6 Active carbon filter
- 7 Security filter
- 8 High pressure pump

- 9 RO module
- 10 Supply pump
- 11 Built-in high pure water tank
- 12 UV lamp

- 13 Point-of-use filter

Heal Force Laboratory Equipment

Heal Force specialises in the design, development, manufacture and sales of laboratory equipments in the fields of Biosafety protection, Centrifugation, Cell culture, Water purification & Gene amplification.



Biosafety Cabinet

Heal Force brand stands for the highest standards of safety, ergonomics and performance. Taking advantage of a heritage from over 25 years experience, Heal Force offers safety features, options and accessories beyond the standard requirements, to fulfill virtually all needs. Thousands of units installed in laboratories in more than 100 Countries.

Centrifuge

Neofuge, the name that defines quality centrifuges from Heal Force. Offering bench-top high speed models with or without refrigeration for today' s discerning laboratory technicians. Neofuge series provide excellent centrifugal effect and maximum application versatility.

CO₂/Tri-Gas Incubator

Heal Force Smart Cell incubator provides you with unsurpassed natural simulation to ensure optimum growth conditions for you culture at all time. That's why it becomes the first choice of researchers in fields of application including tissue engineering, in vitro fertilization, neuroscience, cancer research and other mammalian cell researches.

Water Purification

Well-proved Heal Force water purification system offers ideal and comprehensive solution for a choice of water qualities that range from primary for simple routine washing and rinsing, through to ultra-high grade for the most critical science and analytical applications.

Thermal Cycler

Since PCR is central for molecular biology research, you need flexible solutions that can help you achieve PCR success for virtually any application. Heal Force has been developing new cycling platforms from economical option to advanced series to empower your search. These instruments are renowned for their reliability, accuracy, and user-friendly interfaces.



Heal Force Bio-Meditech Holdings Group Nison Instrument (Shanghai) Limited

16th Floor, Building B, SOHO Zhongshan Plaza, 1065 West Zhongshan Road,
Changning District, Shanghai 200051, China

Tel: +86 21 62728646

E-mail: export@healforce.com

Fax: +86 21 62710529

Website: www.healforce.com

Information is subject to change and/or updating without notice.
Copyright © 2015 Heal Force. All Rights Reserved.

P/N:CL-NISON-EN-PCR-20150203